



Service unit combinations LFR-K/LFRS-K, D series



Service unit combinations LFR-K/LFRS-K, D series, metal design

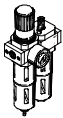
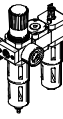
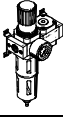
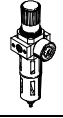
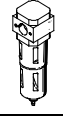
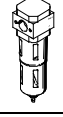
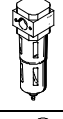

Product range overview D series service units, metal design

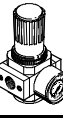
Type	Size	Pneumatic connection										Pressure regulation range [bar]			Grade of filtration [µm]			
		M5	M7	G1/8	G1/4	G3/8	G1/2	G3/4	G1	QS4	QS6	0.5 ...	0.5 ...	2.5 ...	0.01	1	5	40
Service units																		
FRC/FRCS 	Micro	■	■	■	-	-	-	-	-	■	■	■	-	-	-	-	■	-
	Mini	-	-	■	■	■	-	-	-	-	-	■	■	-	-	-	■	■
	Midi	-	-	-	■	■	■	■	-	-	-	■	■	-	-	-	■	■
	Maxi	-	-	-	-	-	■	■	■	-	-	■	■	-	-	-	■	■
Service unit combinations																		
FRC-K 	Micro	-	-	-	-	-	-	-	-	-	-	-	-	-	-	-	-	
	Mini	-	-	■	■	-	-	-	-	-	-	-	■	■	-	-	-	■
	Midi	-	-	-	■	■	■	-	-	-	-	-	■	■	-	-	-	■
	Maxi	-	-	-	-	-	■	■	-	-	-	-	■	■	-	-	-	■
LFR-K LFRS-K 	Micro	-	-	-	-	-	-	-	-	-	-	-	-	-	-	-	-	
	Mini	-	-	■	■	-	-	-	-	-	-	-	■	■	-	-	-	■
	Midi	-	-	-	■	■	■	-	-	-	-	-	■	■	-	-	-	■
	Maxi	-	-	-	-	-	■	■	-	-	-	-	■	■	-	-	-	■
Individual devices																		
Filter regulators LFR/LFRS 	Micro	■	■	■	-	-	-	-	-	■	■	■	-	-	-	-	■	-
	Mini	-	-	■	■	■	-	-	-	-	-	■	■	-	-	-	■	■
	Midi	-	-	-	■	■	■	■	-	-	-	■	■	-	-	-	■	■
	Maxi	-	-	-	-	-	■	■	■	-	-	■	■	-	-	-	■	■
Filters LF 	Micro	■	■	■	-	-	-	-	-	■	■	-	-	-	-	-	■	-
	Mini	-	-	■	■	■	-	-	-	-	-	-	-	-	-	-	■	■
	Midi	-	-	-	■	■	■	■	-	-	-	-	-	-	-	-	■	■
	Maxi	-	-	-	-	-	■	■	■	-	-	-	-	-	-	-	■	■
Fine and micro filters LFMA/LFMB 	Micro	-	-	-	-	-	-	-	-	-	-	-	-	-	-	-	-	
	Mini	-	-	■	■	■	-	-	-	-	-	-	-	-	■	■	-	-
	Midi	-	-	-	■	■	■	■	-	-	-	-	-	-	■	■	-	-
	Maxi	-	-	-	-	-	■	■	■	-	-	-	-	-	■	■	-	-
Active carbon filters LFX 	Micro	-	-	-	-	-	-	-	-	-	-	-	-	-	-	-	-	
	Mini	-	-	■	■	■	-	-	-	-	-	-	-	-	-	-	-	-
	Midi	-	-	-	■	■	■	■	-	-	-	-	-	-	-	-	-	-
	Maxi	-	-	-	-	-	■	■	■	-	-	-	-	-	-	-	-	-
Filter combinations LFMBA 	Micro	-	-	-	-	-	-	-	-	-	-	-	-	-	-	-	-	
	Mini	-	-	■	■	■	-	-	-	-	-	-	-	-	■	■	-	-
	Midi	-	-	-	■	■	■	■	-	-	-	-	-	-	■	■	-	-
	Maxi	-	-	-	-	-	■	■	■	-	-	-	-	-	■	■	-	-
Pressure regulators LRS/LRS 	Micro	■	■	■	-	-	-	-	-	■	■	■	-	-	-	-	-	
	Mini	-	-	■	■	■	-	-	-	-	-	■	■	-	-	-	-	-
	Midi	-	-	-	■	■	■	■	-	-	-	■	■	-	-	-	-	-
	Maxi	-	-	-	-	-	■	■	■	-	-	■	■	-	-	-	-	-



Service unit combinations LFR-K/LFRS-K, D series, metal design

Product range overview D series service units, metal design

Type	Size	Bowl guard		Condensate drain			Pressure indication		Actuator lock		Supply voltage			Options			→ Page/ Internet
		Metal bowl guard	Plastic bowl	Manual rotary	Semi-automatic	Fully automatic	With pressure gauge	Without pressure gauge	Rotary knob with detent	Rotary knob with integrated lock	24 V DC	110 V AC	230 V AC	Directly actuated pressure regulator with integrated return flow function	Pilot actuated pressure regulator with integrated return flow function	Differential pressure indicator	
Service units																	
FRC/FRCS	Micro	-	■	■	■	-	■	■	■	-	-	-	-	-	-	-	frc
	Mini	■	-	■	-	■	■	■	■	■	-	-	-	-	-	-	
	Midi	■	-	■	-	■	■	■	■	■	-	-	-	-	-	-	
	Maxi	■	-	■	-	■	■	■	■	■	-	-	-	■	■	-	
Service unit combinations																	
FRC-K	Micro	-	-	-	-	-	-	-	-	-	-	-	-	-	-	-	frc
	Mini	■	-	■	-	■	■	-	■	-	■	-	-	-	-	-	
	Midi	■	-	■	-	■	■	-	■	-	■	-	-	-	-	-	
	Maxi	■	-	■	-	■	■	-	■	-	■	-	-	■	■	-	
LFR-K LFRS-K	Micro	-	-	-	-	-	-	-	-	-	-	-	-	-	-	-	6
	Mini	■	-	■	-	■	■	-	■	■	■	-	-	-	-	-	
	Midi	■	-	■	-	■	■	-	■	■	■	-	-	-	-	-	
	Maxi	■	-	■	-	■	■	-	■	■	■	-	-	■	■	-	
Individual devices																	
Filter regulators LFR/LFRS	Micro	-	■	■	■	-	■	■	■	-	-	-	-	-	-	-	lfr
	Mini	■	-	■	-	■	■	■	■	■	-	-	-	-	-	-	
	Midi	■	-	■	-	■	■	■	■	■	-	-	-	-	-	-	
	Maxi	■	-	■	-	■	■	■	■	■	-	-	-	■	■	-	
Filters LF	Micro	-	■	■	■	-	-	-	-	-	-	-	-	-	-	-	lf
	Mini	■	-	■	-	■	-	-	-	-	-	-	-	-	-	-	
	Midi	■	-	■	-	■	-	-	-	-	-	-	-	-	-	-	
	Maxi	■	-	■	-	■	-	-	-	-	-	-	-	-	-	-	
Fine and micro filters LFMA/LFMB	Micro	-	-	-	-	-	-	-	-	-	-	-	-	-	-	-	lfma, lfmb
	Mini	■	-	■	-	■	-	-	-	-	-	-	-	-	-	■	
	Midi	■	-	■	-	■	-	-	-	-	-	-	-	-	-	■	
	Maxi	■	-	■	-	■	-	-	-	-	-	-	-	-	-	■	
Active carbon filters LFX	Micro	-	-	-	-	-	-	-	-	-	-	-	-	-	-	-	lfx
	Mini	■	-	-	-	-	-	-	-	-	-	-	-	-	-	-	
	Midi	■	-	-	-	-	-	-	-	-	-	-	-	-	-	-	
	Maxi	■	-	-	-	-	-	-	-	-	-	-	-	-	-	-	
Filter combinations LFMBA	Micro	-	-	-	-	-	-	-	-	-	-	-	-	-	-	-	lfmba
	Mini	■	-	■	-	■	-	-	-	-	-	-	-	-	-	■	
	Midi	■	-	■	-	■	-	-	-	-	-	-	-	-	-	■	
	Maxi	■	-	■	-	■	-	-	-	-	-	-	-	-	-	■	
Pressure regulators LR/LRS	Micro	-	-	-	-	-	■	■	■	-	-	-	-	-	-	-	lr
	Mini	-	-	-	-	-	■	■	■	■	-	-	-	■	-	-	
	Midi	-	-	-	-	-	■	■	■	■	-	-	-	■	-	-	
	Maxi	-	-	-	-	-	■	■	■	■	-	-	-	■	■	-	

Service unit combinations LFR-K/LFRS-K, D series, metal design

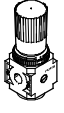
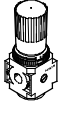
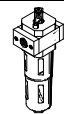
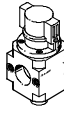
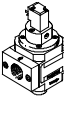
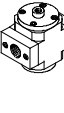
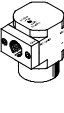
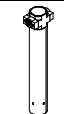
Product range overview D series service units, metal design

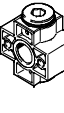
Type	Size	Pneumatic connection										Pressure regulation range [bar]		
		M5	M7	G1/8	G1/4	G3/8	G1/2	G3/4	G1	QS4	QS6	0.5 ... 7	0.5 ... 12	
Individual devices														
Pressure regulators LRB/LRBS		Micro	-											
		Mini	-	-	-	■	-	-	-	-	-	-	■	■
		Midi	-	-	-	-	■	-	-	-	-	-	■	■
		Maxi	-											
Pressure regulator combinations LRB-K		Micro	-											
		Mini	-	-	-	■	■	-	-	-	-	-	■	■
		Midi	-	-	-	-	■	■	-	-	-	-	■	■
		Maxi	-											
Lubricators LOE		Micro	■	■	■	-	-	-	-	-	■	■	-	-
		Mini	-	-	■	■	■	-	-	-	-	-	-	-
		Midi	-	-	-	■	■	■	■	-	-	-	-	-
		Maxi	-	-	-	-	-	■	■	■	-	-	-	-
On-off valves HE		Micro	-											
		Mini	-	-	■	■	■	-	-	-	-	-	-	-
		Midi	-	-	-	■	■	■	■	-	-	-	-	-
		Maxi	-	-	-	-	-	■	■	■	-	-	-	-
On-off valves, electrical HEE		Micro	-											
		Mini	-	-	■	■	■	-	-	-	-	-	-	-
		Midi	-	-	-	■	■	■	■	-	-	-	-	-
		Maxi	-	-	-	-	-	■	■	■	-	-	-	-
On-off valves, pneumatic HEP		Micro	-											
		Mini	-	-	■	■	■	-	-	-	-	-	-	-
		Midi	-	-	-	■	■	■	■	-	-	-	-	-
		Maxi	-	-	-	-	-	■	■	■	-	-	-	-
Soft-start valves HEL		Micro	-											
		Mini	-	-	■	■	■	-	-	-	-	-	-	-
		Midi	-	-	-	■	■	■	■	-	-	-	-	-
		Maxi	-	-	-	-	-	■	■	■	-	-	-	-
Membrane air dryers LDM1		Micro	-											
		Mini	-											
		Midi	-											
		Maxi	-	-	-	-	-	■	■	■	-	-	-	-
Branching modules FRM		Micro	-											
		Mini	-	-	■	■	■	-	-	-	-	-	-	-
		Midi	-	-	-	■	■	■	■	-	-	-	-	-
		Maxi	-	-	-	-	-	■	■	■	-	-	-	-
Distributor block FRZ		Micro	-											
		Mini	-											
		Midi	-											
		Maxi	-											

Service unit combinations LFR-K/LFRS-K, D series, metal design

Product range overview D series service units, metal design

Type	Size	Bowl guard		Pressure indication		Actuator lock		Supply voltage			Options		→ Page/ Internet
		Metal bowl guard	Plastic bowl	With pressure gauge	Without pressure gauge	Rotary knob with detent	Rotary knob with integrated lock	24 V DC	110 V AC	230 V AC	Non-return function	Pressure switch	
Individual devices													
Pressure regulators LRB/LRBS	Micro	-	-	-	■	■	■	-	-	-	-	-	lrb
	Mini	-	-	-	■	■	■	-	-	-	-	-	
	Midi	-	-	-	■	■	■	-	-	-	-	-	
	Maxi	-	-	-	■	■	■	-	-	-	-	-	
Pressure regulator combinations LRB-K	Micro	-	-	-	■	■	-	-	-	-	-	-	lrb
	Mini	-	-	-	■	■	-	-	-	-	-	-	
	Midi	-	-	-	■	■	-	-	-	-	-	-	
	Maxi	-	-	-	■	■	-	-	-	-	-	-	
Lubricators LOE	Micro	-	■	-	■	-	-	-	-	-	-	-	loe
	Mini	■	-	-	■	-	-	-	-	-	-	-	
	Midi	■	-	-	■	-	-	-	-	-	-	-	
	Maxi	■	-	-	■	-	-	-	-	-	-	-	
On-off valves HE	Micro	-	-	-	■	■	-	-	-	-	-	-	he
	Mini	-	-	-	■	■	-	-	-	-	-	-	
	Midi	-	-	-	■	■	-	-	-	-	-	-	
	Maxi	-	-	-	■	■	-	-	-	-	-	-	
On-off valves, electrical HEE	Micro	-	-	-	■	-	-	■	■	■	-	-	hee
	Mini	-	-	-	■	-	-	■	■	■	-	-	
	Midi	-	-	-	■	-	-	■	■	■	-	-	
	Maxi	-	-	-	■	-	-	■	■	■	-	-	
On-off valves, pneumatic HEP	Micro	-	-	-	■	-	-	-	-	-	-	-	hep
	Mini	-	-	-	■	-	-	-	-	-	-	-	
	Midi	-	-	-	■	-	-	-	-	-	-	-	
	Maxi	-	-	-	■	-	-	-	-	-	-	-	
Soft-start valves HEL	Micro	-	-	-	■	-	-	-	-	-	-	-	hel
	Mini	-	-	-	■	-	-	-	-	-	-	-	
	Midi	-	-	-	■	-	-	-	-	-	-	-	
	Maxi	-	-	-	■	-	-	-	-	-	-	-	
Membrane air dryers LDM1	Micro	-	-	-	■	-	-	-	-	-	-	-	ldm1
	Mini	-	-	-	■	-	-	-	-	-	-	-	
	Midi	-	-	-	■	-	-	-	-	-	-	-	
	Maxi	■	-	-	■	-	-	-	-	-	-	-	
Branching modules FRM	Micro	-	-	-	■	-	-	-	-	-	■	■	frm
	Mini	-	-	-	■	-	-	-	-	-	■	■	
	Midi	-	-	-	■	-	-	-	-	-	■	■	
	Maxi	-	-	-	■	-	-	-	-	-	■	■	
Distributor block FRZ	Micro	-	-	-	■	-	-	-	-	-	-	-	frz
	Mini	-	-	-	■	-	-	-	-	-	-	-	
	Midi	-	-	-	■	-	-	-	-	-	-	-	
	Maxi	-	-	-	■	-	-	-	-	-	-	-	

Service unit combinations LFR-K/LFRS-K, D series, metal design

Product range overview

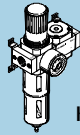
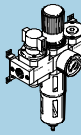
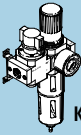
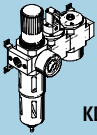
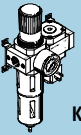
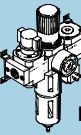
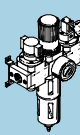
LFR Rotary knob with detent	 KA	 KB	 KC	 KD	 KE	 KF	 KG
Individual devices							
On-off valve manually actuated	-	■	■	-	-	■	■
Filter regulator with pressure gauge	■	■	■	■	■	■	■
Branching module	■	■	-	-	-	-	-
On-off valve solenoid actuated, 24 V DC	-	-	-	■	-	-	■
Soft-start valve pneumatically actuated	-	-	-	■	-	-	■
Branching module with pressure switch	-	-	-	-	■	■	■
Mounting bracket	■	■	■	■	■	■	■
→ Page/Internet	9	13	17	21	25	29	33

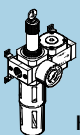
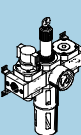
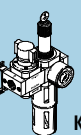
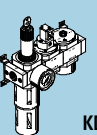
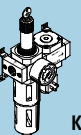
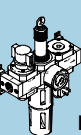
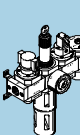
LFRS Rotary knob with integrated lock	 KA	 KB	 KC	 KD	 KE	 KF	 KG
Individual devices							
On-off valve manually actuated	-	■	■	-	-	■	■
Filter regulator with pressure gauge	■	■	■	■	■	■	■
Branching module	■	■	-	-	-	-	-
On-off valve with solenoid actuated, 24 V DC	-	-	-	■	-	-	■
Soft-start valve pneumatically actuated	-	-	-	■	-	-	■
Branching module with pressure switch	-	-	-	-	■	■	■
Mounting bracket	■	■	■	■	■	■	■
→ Page/Internet	9	13	17	21	25	29	33

Service unit combinations LFR-K/LFRS-K, D series, metal design

Peripherals overview

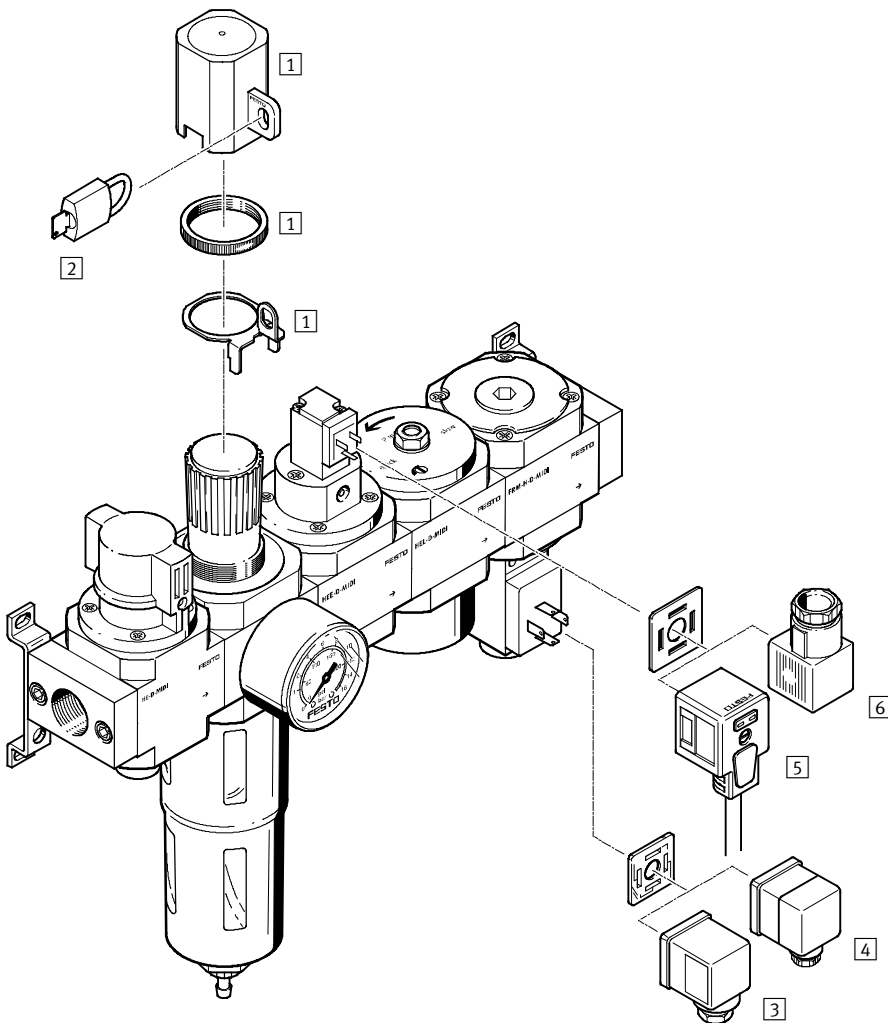

Note

The choice of accessories depends on the selected service unit combination. The example shows the service unit combination LFR-KG. This combination can also be obtained with a lockable rotary regulator as service unit combination LFRS-KG.

Range of accessories
 → Peripherals pages of the individual devices

Mounting attachments and accessories		→ Page/Internet
1	Regulator lock LRVS	lrvs-d
2	Padlock LRVS	lrvs-d
3	Plug socket MSSD-C	37
4	Angled plug socket PEV-...-WD-LED	37
5	Plug socket with cable KMEB-1	37
6	Plug socket MSSD-EB	37

Service unit combinations LFR-K/LFRS-K, D series, metal design

Type codes

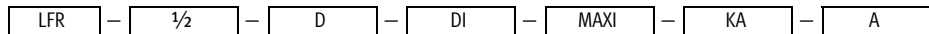

Basic function

LFR	Service unit combination
LFRS	Service unit combination, lockable

Pneumatic connection

1/8	Thread G1/8
1/4	Thread G1/4
3/8	Thread G3/8
1/2	Thread G1/2
3/4	Thread G3/4

Series

D	Series
---	--------

Function (LFR and MAXI size only)

DI	Directly actuated pressure regulator with integrated return flow function
----	---

Size

MINI	Grid dimension for individual device 40 mm (without connecting plates)
MIDI	Grid dimension for individual device 55 mm (without connecting plates)
MAXI	Grid dimension for individual device 66 mm (without connecting plates)

Options for service unit combinations

KA	Filter regulator, branching module
KB	On-off valve manually actuated, filter regulator, branching module
KC	On-off valve manually actuated, filter regulator
KD	Filter regulator, on-off valve solenoid actuated, 24 V DC, soft-start valve pneumatically actuated
KE	Filter regulator, branching module with pressure switch
KF	On-off valve manually actuated, filter regulator, branching module with pressure switch
KG	On-off valve manually actuated, filter regulator, on-off valve solenoid actuated, 24 V DC, soft-start valve pneumatically actuated, branching module with pressure switch

Condensate drain

	Turned manually
A	Fully automatic

Service unit combinations LFR-KA/LFRS-KA, D series, metal design

Technical data combination LFR-KA/LFRS-KA

LFR/LFRS-...-MINI/MIDI-KA
With condensate drain
manual rotary

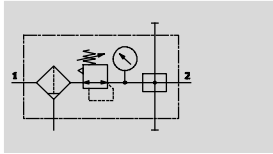

LFR/LFRS-...-MAXI-KA
With condensate drain
manual rotary

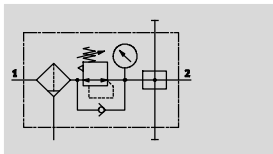

- Flow rate
720 ... 9,400 l/min
- Temperature range
-10 ... +60 °C
- Operating pressure
1 ... 16 bar

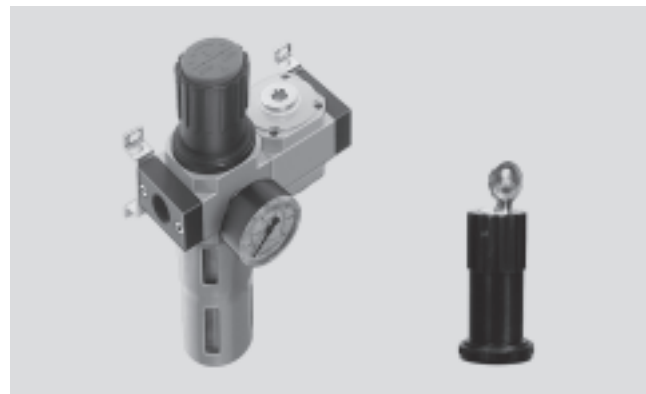

- For unlubricated compressed air supply
- Three branch connections are available

- Filter regulator LFR/LFRS
- Branching module FRM
- Mounting accessories

General technical data							
Size	Mini		Midi			Maxi	
Pneumatic connection 1, 2	G1/8	G1/4	G1/4	G3/8	G1/2	G1/2	G3/4
Type of mounting	Via accessories						
	In-line installation						
Assembly position	Vertical ±5°						
Grade of filtration [µm]	40						
Bowl guard	Metal bowl guard						
Condensate drain	Manual rotary						
	Fully automatic						
Actuator lock	Rotary knob with detent						
	Rotary knob with integrated lock						
Pressure regulation range [bar]	0.5 ... 12						
Max. hysteresis [bar]	0.15	0.15	0.25	0.2	0.2	0.2	0.3
Pressure indication	Via pressure gauge						
Max. condensate volume [cm ³]	22		43			80 (43) ¹⁾	

1) For the LFR-...-D-DI.

- Note: This product conforms to ISO 1179-1 and to ISO 228-1

Standard nominal flow rate $q_{nN}^{1)}$ [l/min]							
Connection	Mini		Midi			Maxi	
	G1/8	G1/4	G1/4	G3/8	G1/2	G1/2	G3/4
In main flow direction 1 → 2	720	1,140	1,850	2,620	3,050	9,200 (5,200) ²⁾	9,400 (5,800) ²⁾

1) Measured at p₁ = 10 bar, p₂ = 6 bar and Δp = 1 bar.

2) For the LFR-...-D-DI.

Service unit combinations LFR-KA/LFRS-KA, D series, metal design

Technical data combination LFR-KA/LFRS-KA

Operating and environmental conditions		
Condensate drain	Manual rotary	Fully automatic
Operating pressure [bar]	1 ... 16	2 ... 12
Operating medium	Compressed air in accordance with ISO 8573-1:2010 [-:-:-]	
Ambient temperature [°C]	-10 ... +60	
Temperature of medium [°C]	-10 ... +60	
Corrosion resistance class CRC ¹⁾	2	
Certification	Germanischer Lloyd	

1) Corrosion resistance class 2 according to Festo standard 940 070
 Components subject to moderate corrosion stress. Externally visible parts with primarily decorative surface requirements which are in direct contact with a normal industrial environment or media such as coolants or lubricating agents.

Weight [g]			
Size	Mini	Midi	Maxi
LFR	800	1,800	2,400 (2,600) ¹⁾
LFRS	900	2,040	2,500

1) For the LFR-...-D-DI.

 - Note
 Materials → Technical data of the individual devices

Standard flow rate qn as a function of the output pressure p2 LFR-1/2-D-DI-MAXI-KA(-A)

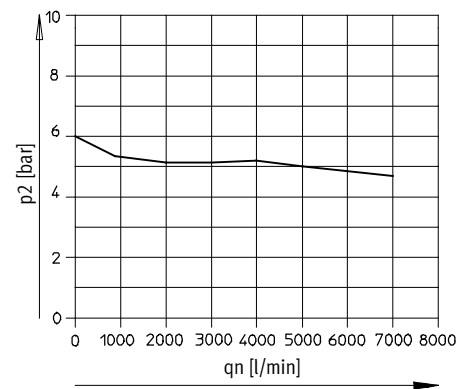

Primary pressure p1 = 10 bar

Service unit combinations LFR-KA/LFRS-KA, D series, metal design

Technical data combination LFR-KA/LFRS-KA

Dimensions Download CAD data → www.festo.com

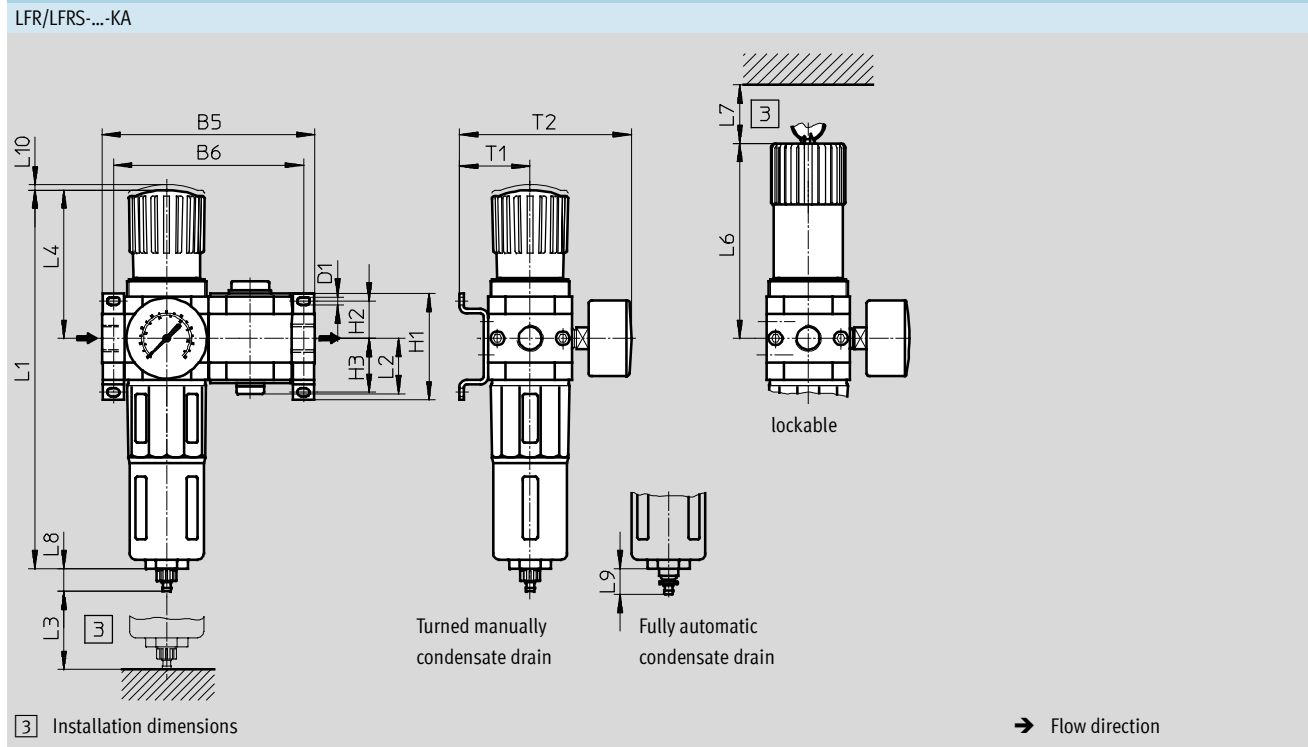

Type	B5	B6	D1	H1	H2	H3	L1	L2	L3	L4	L6	L7	L8	L9	L10	T1	T2
Mini																	
LFR-...-D-MINI-KA (A)	104	92	4.3	43	17.5	17.5	193	28	60	68	98	60	15	19	3	39	95
LFRS-...-D-MINI-KA (A)																	
Midi																	
LFR-...-D-MIDI-KA (A)	140	125	5.3	70	24.5	35.5	250	36.5	80	99	130	60	15	19	3	47	114
LFRS-...-D-MIDI-KA (A)																	
Maxi																	
LFR-...-D-MAXI-KA (A)	162	146	5.3	70	24.5	35.5	252	42	90	82	111	60	15	19	3	53	126
LFRS-...-D-MAXI-KA (A)							275			105	135						
LFR-...-D-DI-MAXI-KA (A)																	

• Note: This product conforms to ISO 1179-1 and to ISO 228-1

Service unit combinations LFR-KA/LFRS-KA, D series, metal design

FESTO

Technical data combination LFR-KA/LFRS-KA

Ordering data					
Pressure regulation range 0.5 ... 12 bar, grade of filtration 40 µm, mounting bracket and metal bowl guard					
Size	Connection	Condensate drain turned manually		Condensate drain fully automatic	
		Part No.	Type	Part No.	Type
Filter regulator, branching module					
Mini	G $\frac{1}{8}$	185707	LFR- $\frac{1}{8}$ -D-MINI-KA	185708	LFR- $\frac{1}{8}$ -D-MINI-KA-A
	G $\frac{1}{4}$	185709	LFR- $\frac{1}{4}$ -D-MINI-KA	185710	LFR- $\frac{1}{4}$ -D-MINI-KA-A
Midi	G $\frac{1}{4}$	185711	LFR- $\frac{1}{4}$ -D-MIDI-KA	185712	LFR- $\frac{1}{4}$ -D-MIDI-KA-A
	G $\frac{3}{8}$	185713	LFR- $\frac{3}{8}$ -D-MIDI-KA	185714	LFR- $\frac{3}{8}$ -D-MIDI-KA-A
	G $\frac{1}{2}$	185715	LFR- $\frac{1}{2}$ -D-MIDI-KA	185716	LFR- $\frac{1}{2}$ -D-MIDI-KA-A
Maxi	G $\frac{1}{2}$	186039	LFR- $\frac{1}{2}$ -D-MAXI-KA	186040	LFR- $\frac{1}{2}$ -D-MAXI-KA-A
	G $\frac{3}{4}$	185717	LFR- $\frac{3}{4}$ -D-MAXI-KA	185718	LFR- $\frac{3}{4}$ -D-MAXI-KA-A
Directly actuated pressure regulator with integrated return flow function					
Maxi	G $\frac{1}{2}$	192440	LFR- $\frac{1}{2}$ -D-DI-MAXI-KA	192454	LFR- $\frac{1}{2}$ -D-DI-MAXI-KA-A
	G $\frac{3}{4}$	192447	LFR- $\frac{3}{4}$ -D-DI-MAXI-KA	192461	LFR- $\frac{3}{4}$ -D-DI-MAXI-KA-A

Ordering data					
Pressure regulation range 0.5 ... 12 bar, grade of filtration 40 µm, mounting bracket and metal bowl guard, lockable					
Size	Connection	Condensate drain turned manually		Condensate drain fully automatic	
		Part No.	Type	Part No.	Type
Filter regulator, branching module					
Mini	G $\frac{1}{8}$	195008	LFRS- $\frac{1}{8}$ -D-MINI-KA	195009	LFRS- $\frac{1}{8}$ -D-MINI-KA-A
	G $\frac{1}{4}$	195022	LFRS- $\frac{1}{4}$ -D-MINI-KA	195023	LFRS- $\frac{1}{4}$ -D-MINI-KA-A
Midi	G $\frac{1}{4}$	195036	LFRS- $\frac{1}{4}$ -D-MIDI-KA	195037	LFRS- $\frac{1}{4}$ -D-MIDI-KA-A
	G $\frac{3}{8}$	195050	LFRS- $\frac{3}{8}$ -D-MIDI-KA	195051	LFRS- $\frac{3}{8}$ -D-MIDI-KA-A
	G $\frac{1}{2}$	195064	LFRS- $\frac{1}{2}$ -D-MIDI-KA	195065	LFRS- $\frac{1}{2}$ -D-MIDI-KA-A
Maxi	G $\frac{1}{2}$	195078	LFRS- $\frac{1}{2}$ -D-MAXI-KA	195079	LFRS- $\frac{1}{2}$ -D-MAXI-KA-A
	G $\frac{3}{4}$	195092	LFRS- $\frac{3}{4}$ -D-MAXI-KA	195093	LFRS- $\frac{3}{4}$ -D-MAXI-KA-A

Service unit combinations LFR-KB/LFRS-KB, D series, metal design

Technical data combination LFR-KB/LFRS-KB

LFR/LFRS-...-MINI/MIDI-KB
With condensate drain
manual rotary

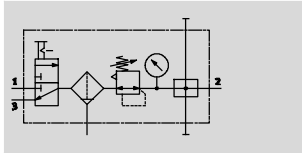

LFR/LFRS-...-MAXI-KB
With condensate drain
manual rotary

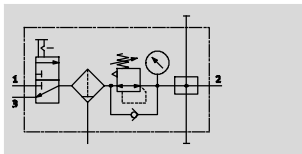

- On-off valve HE manually actuated
- Filter regulator LFR/LFRS
- Branching module FRM
- Mounting accessories

- Flow rate
700 ... 8,400 l/min
- Temperature range
-10 ... +60 °C
- Operating pressure
1 ... 16 bar

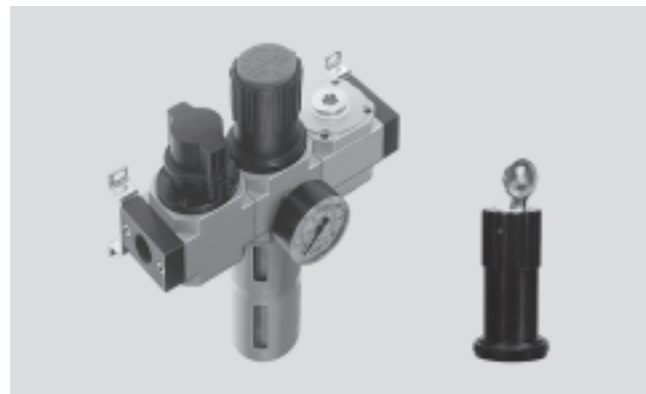

- For unlubricated compressed air supply
- Operating pressure can be opened and closed
- Three branch connections are available
- To ensure safe venting of the system, an additional quick exhaust valve is necessary at the output of the service unit combination

General technical data							
Size	Mini		Midi			Maxi	
Pneumatic connection 1, 2	G1/8	G1/4	G1/4	G3/8	G1/2	G1/2	G3/4
Type of mounting	Via accessories In-line installation						
Assembly position	Vertical ±5°						
Grade of filtration [µm]	40						
Bowl guard	Metal bowl guard						
Condensate drain	Manual rotary Fully automatic						
Actuator lock	Rotary knob with detent Rotary knob with integrated lock						
Pressure regulation range [bar]	0.5 ... 12						
Max. hysteresis [bar]	0.2	0.2	0.25	0.35	0.35	0.1	0.2
Pressure indication	Via pressure gauge						
Max. condensate volume [cm ³]	22		43			80 (43) ¹⁾	

1) For the LFR-...-D-DI.

- | - Note: This product conforms to ISO 1179-1 and to ISO 228-1

Standard nominal flow rate $q_{mN}^{1)}$ [l/min]							
Connection	Mini		Midi			Maxi	
	G1/8	G1/4	G1/4	G3/8	G1/2	G1/2	G3/4
In main flow direction 1 → 2	700	1,050	1,720	2,420	2,920	8,000 (5,400) ²⁾	8,400 (7,000) ²⁾

1) Measured at p₁ = 10 bar, p₂ = 6 bar and Δp = 1 bar.

2) For the LFR-...-D-DI.

Service unit combinations LFR-KB/LFRS-KB, D series, metal design

Technical data combination LFR-KB/LFRS-KB

Operating and environmental conditions		
Condensate drain	Manual rotary	Fully automatic
Operating pressure [bar]	1 ... 16	2 ... 12
Operating medium	Compressed air in accordance with ISO 8573-1:2010 [-:-:-]	
Ambient temperature [°C]	-10 ... +60	
Temperature of medium [°C]	-10 ... +60	
Corrosion resistance class CRC ¹⁾	2	
Certification	Germanischer Lloyd	

1) Corrosion resistance class 2 according to Festo standard 940 070
 Components subject to moderate corrosion stress. Externally visible parts with primarily decorative surface requirements which are in direct contact with a normal industrial environment or media such as coolants or lubricating agents.

Weight [g]			
Size	Mini	Midi	Maxi
LFR	1,000	2,200	3,300 (3,500) ¹⁾
LFRS	1,100	2,440	3,400

1) For the LFR-...-D-DI.

 - Note
 Materials → Technical data of the individual devices

Standard flow rate qn as a function of the output pressure p2 LFR-1/2-D-DI-MAXI-KB(-A)

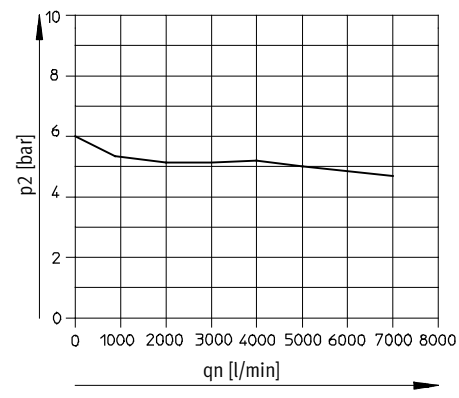

Primary pressure p1 = 10 bar

Service unit combinations LFR-KB/LFRS-KB, D series, metal design

Technical data combination LFR-KB/LFRS-KB

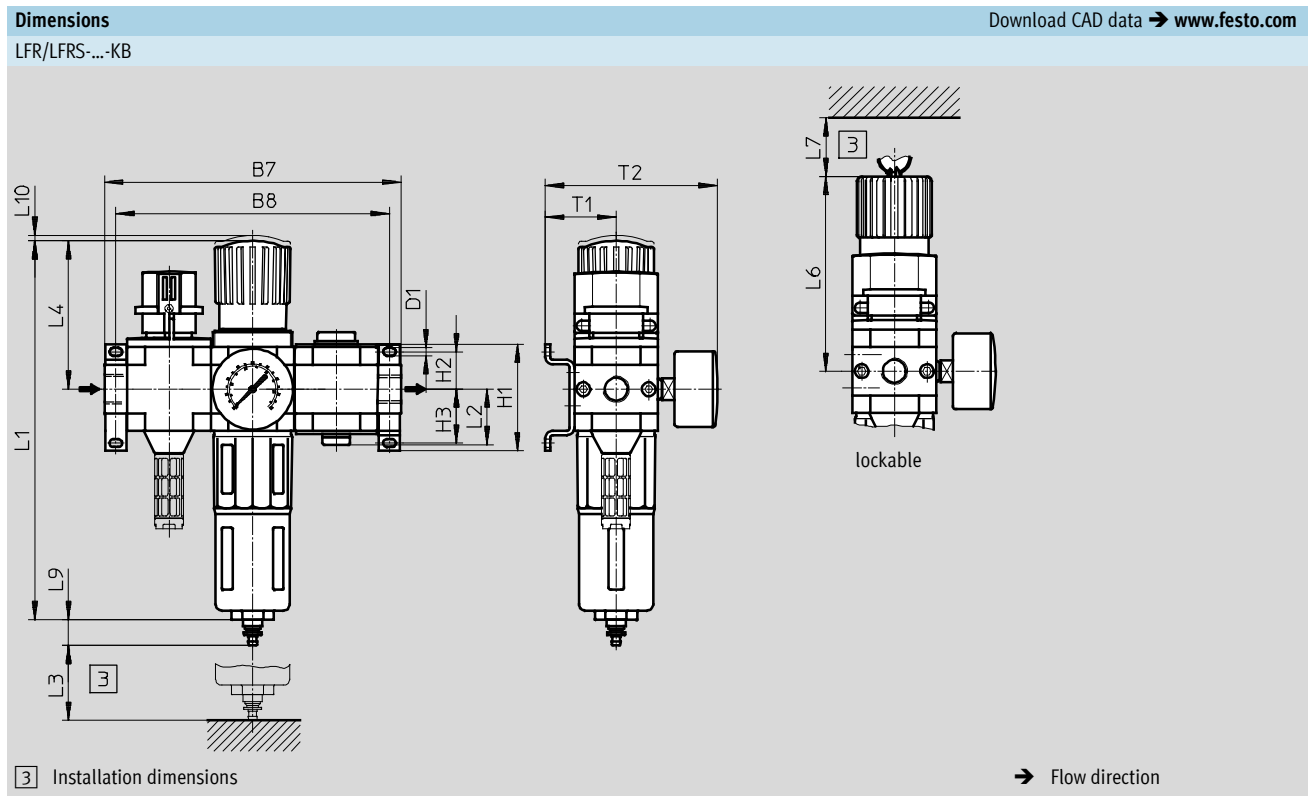

Type	B7	B8	D1	H1	H2	H3	L1	L2	L3	L4	L6	L7	L9	L10	T1	T2
Mini																
LFR-...-D-MINI-KB (A)	144	132	4.3	43	17.5	17.5	193	28	60	68	98	60	19	3	39	95
LFRS-...-D-MINI-KB (A)																
Midi																
LFR-...-D-MIDI-KB (A)	195	180	5.3	70	24.5	35.5	250	36.5	80	99	130	60	19	3	47	114
LFRS-...-D-MIDI-KB (A)																
Maxi																
LFR-...-D-MAXI-KB (A)	228	212	5.3	70	24.5	35.5	252	42	90	82	111	60	19	3	53	126
LFRS-...-D-MAXI-KB (A)							275			105	135					
LFR-...-D-DI-MAXI-KB (A)																

• † - Note: This product conforms to ISO 1179-1 and to ISO 228-1

Service unit combinations LFR-KB/LFRS-KB, D series, metal design

FESTO

Technical data combination LFR-KB/LFRS-KB

Ordering data					
Pressure regulation range 0.5 ... 12 bar, grade of filtration 40 µm, mounting bracket and metal bowl guard					
Size	Connection	Condensate drain turned manually		Condensate drain fully automatic	
		Part No.	Type	Part No.	Type
On-off valve, filter regulator, branching module					
Mini	G $\frac{1}{8}$	185719	LFR- $\frac{1}{8}$ -D-MINI-KB	185720	LFR- $\frac{1}{8}$ -D-MINI-KB-A
	G $\frac{1}{4}$	185721	LFR- $\frac{1}{4}$ -D-MINI-KB	185722	LFR- $\frac{1}{4}$ -D-MINI-KB-A
Midi	G $\frac{1}{4}$	185723	LFR- $\frac{1}{4}$ -D-MIDI-KB	185724	LFR- $\frac{1}{4}$ -D-MIDI-KB-A
	G $\frac{3}{8}$	185725	LFR- $\frac{3}{8}$ -D-MIDI-KB	185726	LFR- $\frac{3}{8}$ -D-MIDI-KB-A
	G $\frac{1}{2}$	185727	LFR- $\frac{1}{2}$ -D-MIDI-KB	185728	LFR- $\frac{1}{2}$ -D-MIDI-KB-A
Maxi	G $\frac{1}{2}$	186041	LFR- $\frac{1}{2}$ -D-MAXI-KB	186042	LFR- $\frac{1}{2}$ -D-MAXI-KB-A
	G $\frac{3}{4}$	185729	LFR- $\frac{3}{4}$ -D-MAXI-KB	185730	LFR- $\frac{3}{4}$ -D-MAXI-KB-A
Directly actuated pressure regulator with integrated return flow function					
Maxi	G $\frac{1}{2}$	192441	LFR- $\frac{1}{2}$ -D-DI-MAXI-KB	192455	LFR- $\frac{1}{2}$ -D-DI-MAXI-KB-A
	G $\frac{3}{4}$	192448	LFR- $\frac{3}{4}$ -D-DI-MAXI-KB	192462	LFR- $\frac{3}{4}$ -D-DI-MAXI-KB-A

Ordering data					
Pressure regulation range 0.5 ... 12 bar, grade of filtration 40 µm, mounting bracket and metal bowl guard, lockable					
Size	Connection	Condensate drain turned manually		Condensate drain fully automatic	
		Part No.	Type	Part No.	Type
On-off valve, filter regulator, branching module					
Mini	G $\frac{1}{8}$	195010	LFRS- $\frac{1}{8}$ -D-MINI-KB	195011	LFRS- $\frac{1}{8}$ -D-MINI-KB-A
	G $\frac{1}{4}$	195024	LFRS- $\frac{1}{4}$ -D-MINI-KB	195025	LFRS- $\frac{1}{4}$ -D-MINI-KB-A
Midi	G $\frac{1}{4}$	195038	LFRS- $\frac{1}{4}$ -D-MIDI-KB	195039	LFRS- $\frac{1}{4}$ -D-MIDI-KB-A
	G $\frac{3}{8}$	195052	LFRS- $\frac{3}{8}$ -D-MIDI-KB	195053	LFRS- $\frac{3}{8}$ -D-MIDI-KB-A
	G $\frac{1}{2}$	195066	LFRS- $\frac{1}{2}$ -D-MIDI-KB	195067	LFRS- $\frac{1}{2}$ -D-MIDI-KB-A
Maxi	G $\frac{1}{2}$	195080	LFRS- $\frac{1}{2}$ -D-MAXI-KB	195081	LFRS- $\frac{1}{2}$ -D-MAXI-KB-A
	G $\frac{3}{4}$	195094	LFRS- $\frac{3}{4}$ -D-MAXI-KB	195095	LFRS- $\frac{3}{4}$ -D-MAXI-KB-A

Service unit combinations LFR-KC/LFRS-KC, D series, metal design

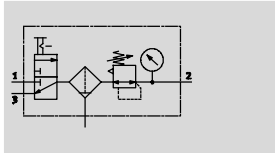

Technical data combination LFR-KC/LFRS-KC

LFR/LFRS-...-MINI/MIDI-KC
With condensate drain
manual rotary

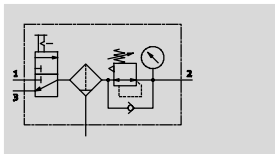

LFR/LFRS-...-MAXI-KC
With condensate drain
manual rotary



-  Flow rate
750 ... 8,400 l/min
-  Temperature range
-10 ... +60 °C
-  Operating pressure
1 ... 16 bar

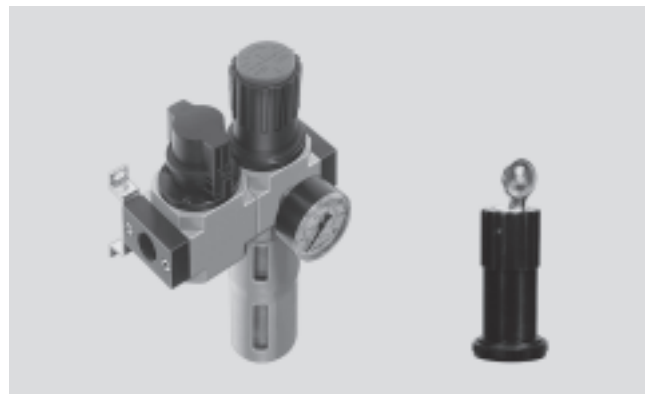

- On-off valve HE manually actuated
- Filter regulator LFR/LFRS
- Mounting accessories

- For unlubricated compressed air
- Operating pressure can be opened and closed
- To ensure safe venting of the system, an additional quick exhaust valve is necessary at the output of the service unit combination

General technical data							
Size	Mini		Midi			Maxi	
Pneumatic connection 1, 2	G1/8	G1/4	G1/4	G3/8	G1/2	G1/2	G3/4
Type of mounting	Via accessories						
	In-line installation						
Assembly position	Vertical ±5°						
Grade of filtration [µm]	40						
Bowl guard	Metal bowl guard						
Condensate drain	Manual rotary						
	Fully automatic						
Actuator lock	Rotary knob with detent						
	Rotary knob with integrated lock						
Pressure regulation range [bar]	0.5 ... 12						
Max. hysteresis [bar]	0.2	0.2	0.2	0.2	0.2	0.2	0.2
Pressure indication	Via pressure gauge						
Max. condensate volume [cm ³]	22		43			80 (43) ¹⁾	

1) For the LFR-...-D-DI.

-  Note: This product conforms to ISO 1179-1 and to ISO 228-1

Standard nominal flow rate $q_{nN}^{1)}$ [l/min]							
Connection	Mini		Midi			Maxi	
	G1/8	G1/4	G1/4	G3/8	G1/2	G1/2	G3/4
In main flow direction 1 → 2	750	1,150	1,900	2,700	3,150	8,100 (4,800) ²⁾	8,400 (5,400) ²⁾

1) Measured at p₁ = 10 bar, p₂ = 6 bar and Δp = 1 bar.

2) For the LFR-...-D-DI.

Service unit combinations LFR-KC/LFRS-KC, D series, metal design

Technical data combination LFR-KC/LFRS-KC

Operating and environmental conditions		
Condensate drain	Manual rotary	Fully automatic
Operating pressure [bar]	1 ... 16	2 ... 12
Operating medium	Compressed air in accordance with ISO 8573-1:2010 [-:-:-]	
Ambient temperature [°C]	-10 ... +60	
Temperature of medium [°C]	-10 ... +60	
Corrosion resistance class CRC ¹⁾	2	
Certification	Germanischer Lloyd	

1) Corrosion resistance class 2 according to Festo standard 940 070
 Components subject to moderate corrosion stress. Externally visible parts with primarily decorative surface requirements which are in direct contact with a normal industrial environment or media such as coolants or lubricating agents.

Weight [g]			
Size	Mini	Midi	Maxi
LFR	700	1,600	2,300 (2,600) ¹⁾
LFRS	1,000	1,840	2,400

1) For the LFR-...-D-DI.

 - Note
 Materials → Technical data of the individual devices

Standard flow rate qn as a function of the output pressure p2 LFR-1/2-D-DI-MAXI-KC(-A)

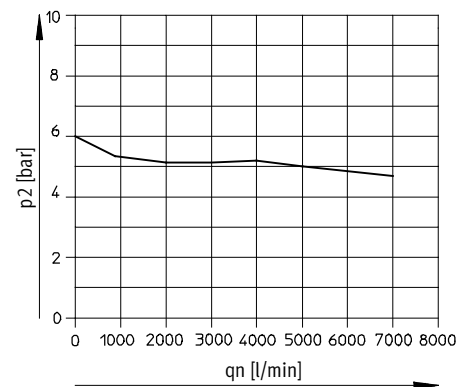

Primary pressure p1 = 10 bar

Service unit combinations LFR-KC/LFRS-KC, D series, metal design

Technical data combination LFR-KC/LFRS-KC

Dimensions Download CAD data → www.festo.com
 LFR/LFRS-...-KC

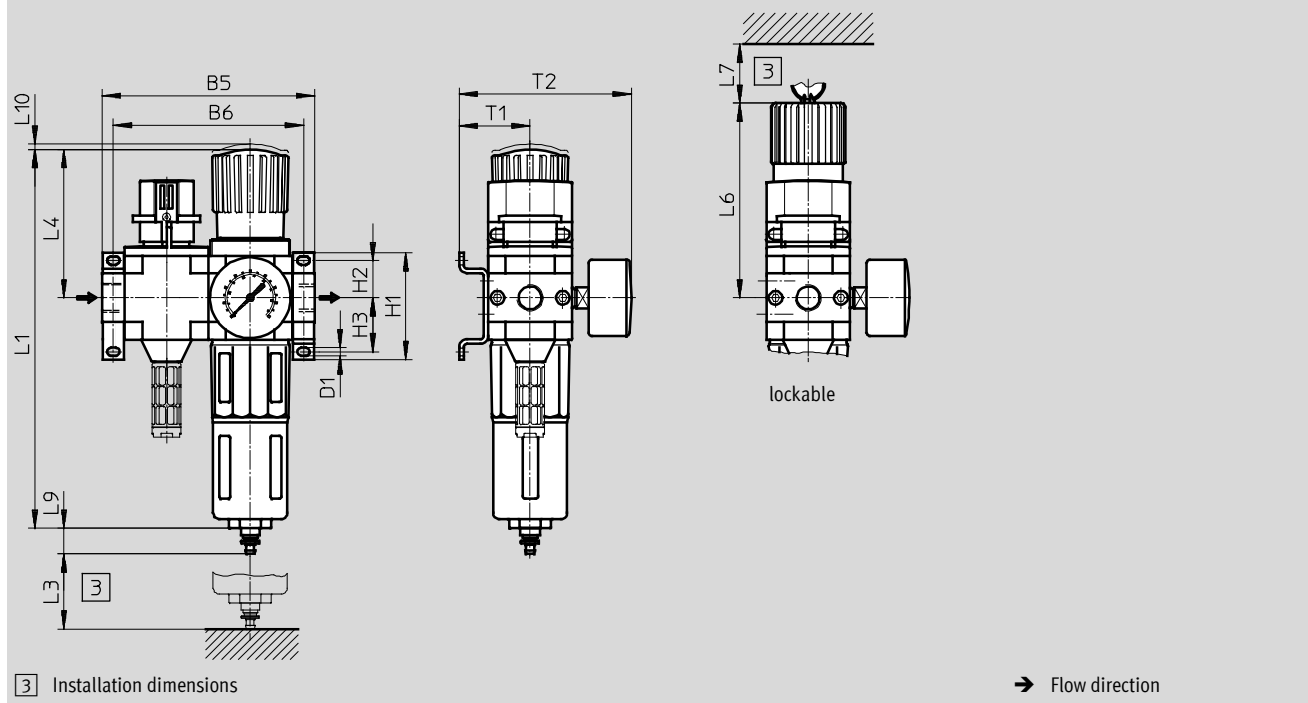

Type	B5	B6	D1	H1	H2	H3	L1	L3	L4	L6	L7	L9	L10	T1	T2
Mini															
LFR-...-D-MINI-KC (A)	104	92	4.3	43	17.5	17.5	193	60	68	98	60	19	3	39	95
LFRS-...-D-MINI-KC (A)															
Midi															
LFR-...-D-MIDI-KC (A)	140	125	5.3	70	24.5	35.5	250	80	99	130	60	19	3	47	114
LFRS-...-D-MIDI-KC (A)															
Maxi															
LFR-...-D-MAXI-KC (A)	162	146	5.3	70	24.5	35.5	252	90	82	111	60	19	3	53	126
LFRS-...-D-MAXI-KC (A)							275		105	135					
LFR-...-D-DI-MAXI-KC (A)															

Note: This product conforms to ISO 1179-1 and to ISO 228-1

Service unit combinations LFR-KC/LFRS-KC, D series, metal design

FESTO

Technical data combination LFR-KC/LFRS-KC

Ordering data					
Pressure regulation range 0.5 ... 12 bar, grade of filtration 40 µm, mounting bracket and metal bowl guard					
Size	Connection	Condensate drain turned manually		Condensate drain fully automatic	
		Part No.	Type	Part No.	Type
On-off valve, filter regulator					
Mini	G $\frac{1}{8}$	185731	LFR- $\frac{1}{8}$ -D-MINI-KC	185732	LFR- $\frac{1}{8}$ -D-MINI-KC-A
	G $\frac{1}{4}$	185733	LFR- $\frac{1}{4}$ -D-MINI-KC	185734	LFR- $\frac{1}{4}$ -D-MINI-KC-A
Midi	G $\frac{1}{4}$	185735	LFR- $\frac{1}{4}$ -D-MIDI-KC	185736	LFR- $\frac{1}{4}$ -D-MIDI-KC-A
	G $\frac{3}{8}$	185737	LFR- $\frac{3}{8}$ -D-MIDI-KC	185738	LFR- $\frac{3}{8}$ -D-MIDI-KC-A
	G $\frac{1}{2}$	185739	LFR- $\frac{1}{2}$ -D-MIDI-KC	185740	LFR- $\frac{1}{2}$ -D-MIDI-KC-A
Maxi	G $\frac{1}{2}$	186043	LFR- $\frac{1}{2}$ -D-MAXI-KC	186044	LFR- $\frac{1}{2}$ -D-MAXI-KC-A
	G $\frac{3}{4}$	185741	LFR- $\frac{3}{4}$ -D-MAXI-KC	185742	LFR- $\frac{3}{4}$ -D-MAXI-KC-A
Directly actuated pressure regulator with integrated return flow function					
Maxi	G $\frac{1}{2}$	192442	LFR- $\frac{1}{2}$ -D-DI-MAXI-KC	192456	LFR- $\frac{1}{2}$ -D-DI-MAXI-KC-A
	G $\frac{3}{4}$	192449	LFR- $\frac{3}{4}$ -D-DI-MAXI-KC	192463	LFR- $\frac{3}{4}$ -D-DI-MAXI-KC-A

Ordering data					
Pressure regulation range 0.5 ... 12 bar, grade of filtration 40 µm, mounting bracket and metal bowl guard, lockable					
Size	Connection	Condensate drain turned manually		Condensate drain fully automatic	
		Part No.	Type	Part No.	Type
On-off valve, filter regulator					
Mini	G $\frac{1}{8}$	195012	LFRS- $\frac{1}{8}$ -D-MINI-KC	195013	LFRS- $\frac{1}{8}$ -D-MINI-KC-A
	G $\frac{1}{4}$	195026	LFRS- $\frac{1}{4}$ -D-MINI-KC	195027	LFRS- $\frac{1}{4}$ -D-MINI-KC-A
Midi	G $\frac{1}{4}$	195040	LFRS- $\frac{1}{4}$ -D-MIDI-KC	195041	LFRS- $\frac{1}{4}$ -D-MIDI-KC-A
	G $\frac{3}{8}$	195054	LFRS- $\frac{3}{8}$ -D-MIDI-KC	195055	LFRS- $\frac{3}{8}$ -D-MIDI-KC-A
	G $\frac{1}{2}$	195068	LFRS- $\frac{1}{2}$ -D-MIDI-KC	195069	LFRS- $\frac{1}{2}$ -D-MIDI-KC-A
Maxi	G $\frac{1}{2}$	195082	LFRS- $\frac{1}{2}$ -D-MAXI-KC	195083	LFRS- $\frac{1}{2}$ -D-MAXI-KC-A
	G $\frac{3}{4}$	195096	LFRS- $\frac{3}{4}$ -D-MAXI-KC	195097	LFRS- $\frac{3}{4}$ -D-MAXI-KC-A

Service unit combinations LFR-KD/LFRS-KD, D series, metal design

Technical data combination LFR-KD/LFRS-KD

LFR/LFRS-...-MINI/MIDI-KD
With condensate drain
manual rotary

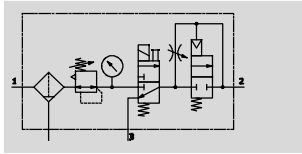

LFR/LFRS-...-MAXI-KD
With condensate drain
manual rotary

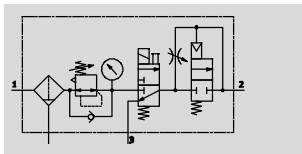

- Filter regulator LFR/LFRS
- On-off valve HEE solenoid actuated, 24 V DC
- Soft-start valve HEL pneumatically actuated
- Mounting accessories

- Flow rate
595 ... 5,000 l/min
- Temperature range
-10 ... +60 °C
- Operating pressure
3 ... 16 bar

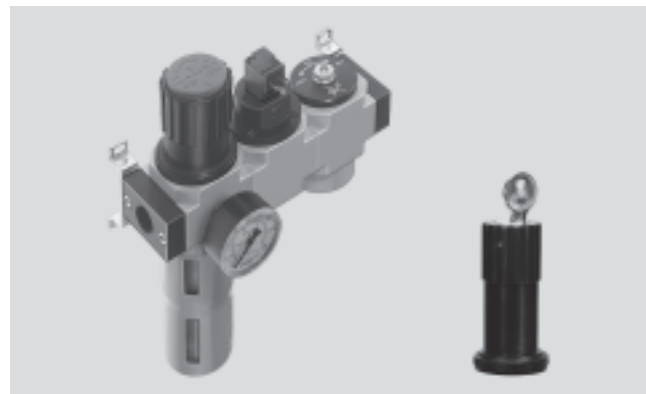

- For unlubricated compressed air
- When operating pressure is closed, quick venting ensures rapid pressure reduction
- Gradual pressure build-up prevents sudden, unpredictable movements

General technical data							
Size	Mini		Midi			Maxi	
Pneumatic connection 1, 2	G $\frac{1}{8}$	G $\frac{1}{4}$	G $\frac{1}{4}$	G $\frac{3}{8}$	G $\frac{1}{2}$	G $\frac{1}{2}$	G $\frac{3}{4}$
Type of mounting	Via accessories In-line installation						
Assembly position	Vertical $\pm 5^\circ$						
Grade of filtration $[\mu\text{m}]$	40						
Bowl guard	Metal bowl guard						
Condensate drain	Manual rotary Fully automatic						
Actuator lock	Rotary knob with detent Rotary knob with integrated lock						
Pressure regulation range [bar]	2.5 ... 12						
Max. hysteresis [bar]	0.15	0.15	0.25	0.25	0.25	0.3	0.2
Pressure indication	Via pressure gauge						
Max. condensate volume $[\text{cm}^3]$	22		43			80 (43) ¹⁾	

1) For the LFR-...-D-DI.

• † - Note: This product conforms to ISO 1179-1 and to ISO 228-1

Standard nominal flow rate $q_{nN}^{1)}$ [l/min]							
Connection	Mini		Midi			Maxi	
	G $\frac{1}{8}$	G $\frac{1}{4}$	G $\frac{1}{4}$	G $\frac{3}{8}$	G $\frac{1}{2}$	G $\frac{1}{2}$	G $\frac{3}{4}$
In main flow direction 1 \rightarrow 2	595	730	1,440	1,890	2,000	4,300 (3,000) ²⁾	5,000 (2,800) ²⁾

1) Measured at $p_1 = 10$ bar, $p_2 = 6$ bar and $\Delta p = 1$ bar.

2) For the LFR-...-D-DI.

Service unit combinations LFR-KD/LFRS-KD, D series, metal design

Technical data combination LFR-KD/LFRS-KD

Operating and environmental conditions		
Condensate drain	Manual rotary	Fully automatic
Operating pressure [bar]	3 ... 16	3 ... 12
Operating medium	Compressed air in accordance with ISO 8573-1:2010 [-:-:-]	
Ambient temperature [°C]	-10 ... +60	
Temperature of medium [°C]	-10 ... +60	
Corrosion resistance class CRC ¹⁾	2	
Certification	Germanischer Lloyd	

1) Corrosion resistance class 2 according to Festo standard 940 070
 Components subject to moderate corrosion stress. Externally visible parts with primarily decorative surface requirements which are in direct contact with a normal industrial environment or media such as coolants or lubricating agents.

Weight [g]			
Size	Mini	Midi	Maxi
LFR	900	2,100	3,100 (3,300) ¹⁾
LFRS	1,000	2,340	3,200

1) For the LFR-...-D-DI.

 - Note
 Materials → Technical data of the individual devices

Standard flow rate qn as a function of the output pressure p2 LFR-1/2-D-DI-MAXI-KD(-A)

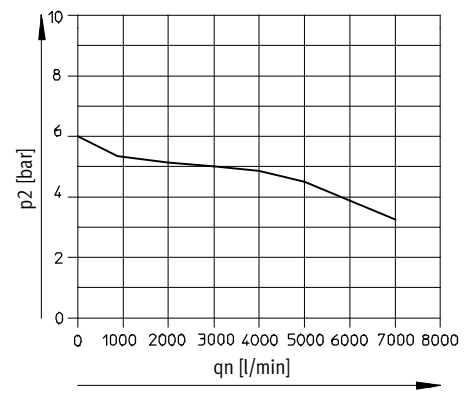

Primary pressure p1 = 10 bar

Service unit combinations LFR-KD/LFRS-KD, D series, metal design

Technical data combination LFR-KD/LFRS-KD

Dimensions Download CAD data → www.festo.com

LFR/LFRS-...-KD

3 Installation dimensions → Flow direction

Type	B7	B8	D1	H1	H2	H3	L1	L2	L3	L4	L6	L7	L9	L10	T1	T2	T4	T5	
Mini																			
LFR-...-D-MINI-KD (A)	144	132	4.3	43	17.5	17.5	193	36	60	68	98	60	19	3	39	95	78	15	
LFRS-...-D-MINI-KD (A)																			
Midi																			
LFR-...-D-MIDI-KD (A)	195	180	5.3	70	24.5	35.5	250	49.5	80	99	130	60	19	3	47	114	86	15	
LFRS-...-D-MIDI-KD (A)																			
Maxi																			
LFR-...-D-MAXI-KD (A)	228	212	5.3	70	24.5	35.5	252	56.4	90	82	111	60	19	3	53	126	92	15	
LFRS-...-D-MAXI-KD (A)							275			105	135								
LFR-...-D-DI-MAXI-KD (A)																			

• Note: This product conforms to ISO 1179-1 and to ISO 228-1

Service unit combinations LFR-KD/LFRS-KD, D series, metal design

FESTO

Technical data combination LFR-KD/LFRS-KD

Ordering data					
Pressure regulation range 2.5 ... 12 bar, grade of filtration 40 µm, mounting bracket and metal bowl guard					
Size	Connection	Condensate drain turned manually		Condensate drain fully automatic	
		Part No.	Type	Part No.	Type
Filter regulator, on-off valve with solenoid coil 24 V DC, soft-start valve					
Mini	G $\frac{1}{8}$	185743	LFR- $\frac{1}{8}$ -D-MINI-KD	185744	LFR- $\frac{1}{8}$ -D-MINI-KD-A
	G $\frac{1}{4}$	185745	LFR- $\frac{1}{4}$ -D-MINI-KD	185746	LFR- $\frac{1}{4}$ -D-MINI-KD-A
Midi	G $\frac{1}{4}$	185747	LFR- $\frac{1}{4}$ -D-MIDI-KD	185748	LFR- $\frac{1}{4}$ -D-MIDI-KD-A
	G $\frac{3}{8}$	185749	LFR- $\frac{3}{8}$ -D-MIDI-KD	185750	LFR- $\frac{3}{8}$ -D-MIDI-KD-A
	G $\frac{1}{2}$	185751	LFR- $\frac{1}{2}$ -D-MIDI-KD	185752	LFR- $\frac{1}{2}$ -D-MIDI-KD-A
Maxi	G $\frac{1}{2}$	186045	LFR- $\frac{1}{2}$ -D-MAXI-KD	186046	LFR- $\frac{1}{2}$ -D-MAXI-KD-A
	G $\frac{3}{4}$	185753	LFR- $\frac{3}{4}$ -D-MAXI-KD	185754	LFR- $\frac{3}{4}$ -D-MAXI-KD-A
Directly actuated pressure regulator with integrated return flow function					
Maxi	G $\frac{1}{2}$	192443	LFR- $\frac{1}{2}$ -D-DI-MAXI-KD	192457	LFR- $\frac{1}{2}$ -D-DI-MAXI-KD-A
	G $\frac{3}{4}$	192450	LFR- $\frac{3}{4}$ -D-DI-MAXI-KD	192464	LFR- $\frac{3}{4}$ -D-DI-MAXI-KD-A

Ordering data					
Pressure regulation range 2.5 ... 12 bar, grade of filtration 40 µm, mounting bracket and metal bowl guard, lockable					
Size	Connection	Condensate drain turned manually		Condensate drain fully automatic	
		Part No.	Type	Part No.	Type
Filter regulator, on-off valve with solenoid coil 24 V DC, soft-start valve					
Mini	G $\frac{1}{8}$	195014	LFRS- $\frac{1}{8}$ -D-MINI-KD	195015	LFRS- $\frac{1}{8}$ -D-MINI-KD-A
	G $\frac{1}{4}$	195028	LFRS- $\frac{1}{4}$ -D-MINI-KD	195029	LFRS- $\frac{1}{4}$ -D-MINI-KD-A
Midi	G $\frac{1}{4}$	195042	LFRS- $\frac{1}{4}$ -D-MIDI-KD	195043	LFRS- $\frac{1}{4}$ -D-MIDI-KD-A
	G $\frac{3}{8}$	195056	LFRS- $\frac{3}{8}$ -D-MIDI-KD	195057	LFRS- $\frac{3}{8}$ -D-MIDI-KD-A
	G $\frac{1}{2}$	195070	LFRS- $\frac{1}{2}$ -D-MIDI-KD	195071	LFRS- $\frac{1}{2}$ -D-MIDI-KD-A
Maxi	G $\frac{1}{2}$	195084	LFRS- $\frac{1}{2}$ -D-MAXI-KD	195085	LFRS- $\frac{1}{2}$ -D-MAXI-KD-A
	G $\frac{3}{4}$	195098	LFRS- $\frac{3}{4}$ -D-MAXI-KD	195099	LFRS- $\frac{3}{4}$ -D-MAXI-KD-A

Service unit combinations LFR-KE/LFRS-KE, D series, metal design

Technical data combination LFR-KE/LFRS-KE

LFR/LFRS-...-MINI/MIDI-KE
With condensate drain
manual rotary

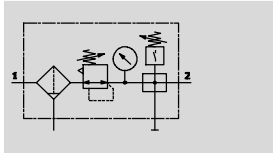

LFR/LFRS-...-MAXI-KE
With condensate drain
manual rotary

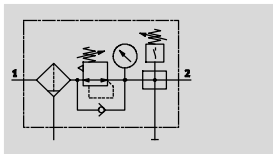

- Filter regulator LFR/LFRS
- Branching module FRM with pressure switch
- Mounting accessories

- Flow rate
720 ... 9,400 l/min
- Temperature range
-10 ... +60 °C
- Operating pressure
1 ... 16 bar

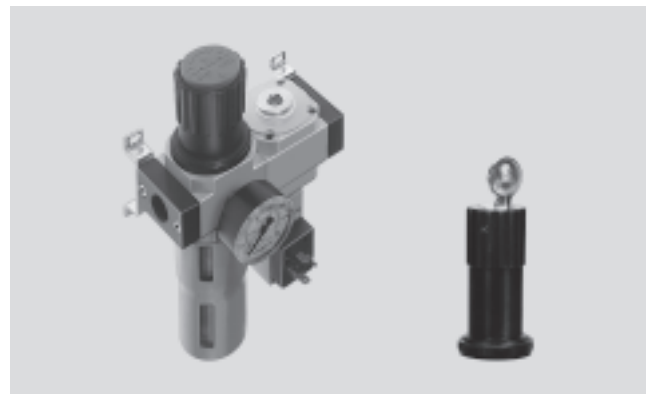

- For unlubricated compressed air
- Two branch connections are available
- Electrical pressure monitoring with adjustable switching pressure

General technical data							
Size	Mini		Midi			Maxi	
Pneumatic connection 1, 2	G1/8	G1/4	G1/4	G3/8	G1/2	G1/2	G3/4
Type of mounting	Via accessories In-line installation						
Assembly position	Vertical ±5°						
Grade of filtration [µm]	40						
Bowl guard	Metal bowl guard						
Condensate drain	Manual rotary Fully automatic						
Actuator lock	Rotary knob with detent Rotary knob with integrated lock						
Pressure regulation range [bar]	0.5 ... 12						
Max. hysteresis [bar]	0.15	0.15	0.25	0.2	0.2	0.2	0.3
Pressure indication	Via pressure gauge						
Max. condensate volume [cm ³]	22		43			80 (43) ¹⁾	

1) For the LFR-...-D-DI.

- | - Note: This product conforms to ISO 1179-1 and to ISO 228-1

Standard nominal flow rate $q_{mN}^{1)}$ [l/min]							
Connection	Mini		Midi			Maxi	
	G1/8	G1/4	G1/4	G3/8	G1/2	G1/2	G3/4
In main flow direction 1 → 2	720	1,140	1,850	2,620	3,050	9,200 (5,000) ²⁾	9,400 (6,000) ²⁾

1) Measured at p₁ = 10 bar, p₂ = 6 bar and Δp = 1 bar.

2) For the LFR-...-D-DI.

Service unit combinations LFR-KE/LFRS-KE, D series, metal design

Technical data combination LFR-KE/LFRS-KE

Operating and environmental conditions		
Condensate drain	Manual rotary	Fully automatic
Operating pressure [bar]	1 ... 16	2 ... 12
Operating medium	Compressed air in accordance with ISO 8573-1:2010 [-:-:-]	
Ambient temperature [°C]	-10 ... +60	
Temperature of medium [°C]	-10 ... +60	
Corrosion resistance class CRC ¹⁾	2	
Certification	Germanischer Lloyd	

1) Corrosion resistance class 2 according to Festo standard 940 070
 Components subject to moderate corrosion stress. Externally visible parts with primarily decorative surface requirements which are in direct contact with a normal industrial environment or media such as coolants or lubricating agents.

Weight [g]			
Size	Mini	Midi	Maxi
LFR	1,000	2,000	2,400 (2,600) ¹⁾
LFRS	1,100	2,240	2,500

1) For the LFR-...-D-DI.

 Note
 Materials → Technical data of the individual devices

Standard flow rate qn as a function of the output pressure p2 LFR-1/2-D-DI-MAXI-KE(-A)

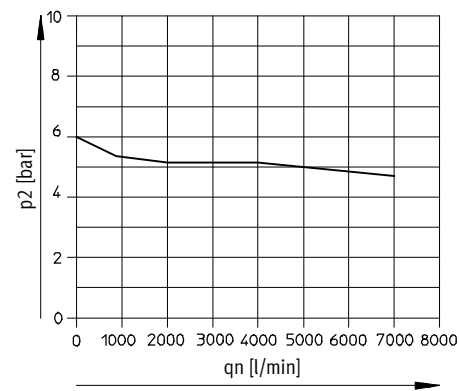

Primary pressure p1 = 10 bar

Service unit combinations LFR-KE/LFRS-KE, D series, metal design

Technical data combination LFR-KE/LFRS-KE

Dimensions Download CAD data → www.festo.com
 LFR/LFRS-...-KE

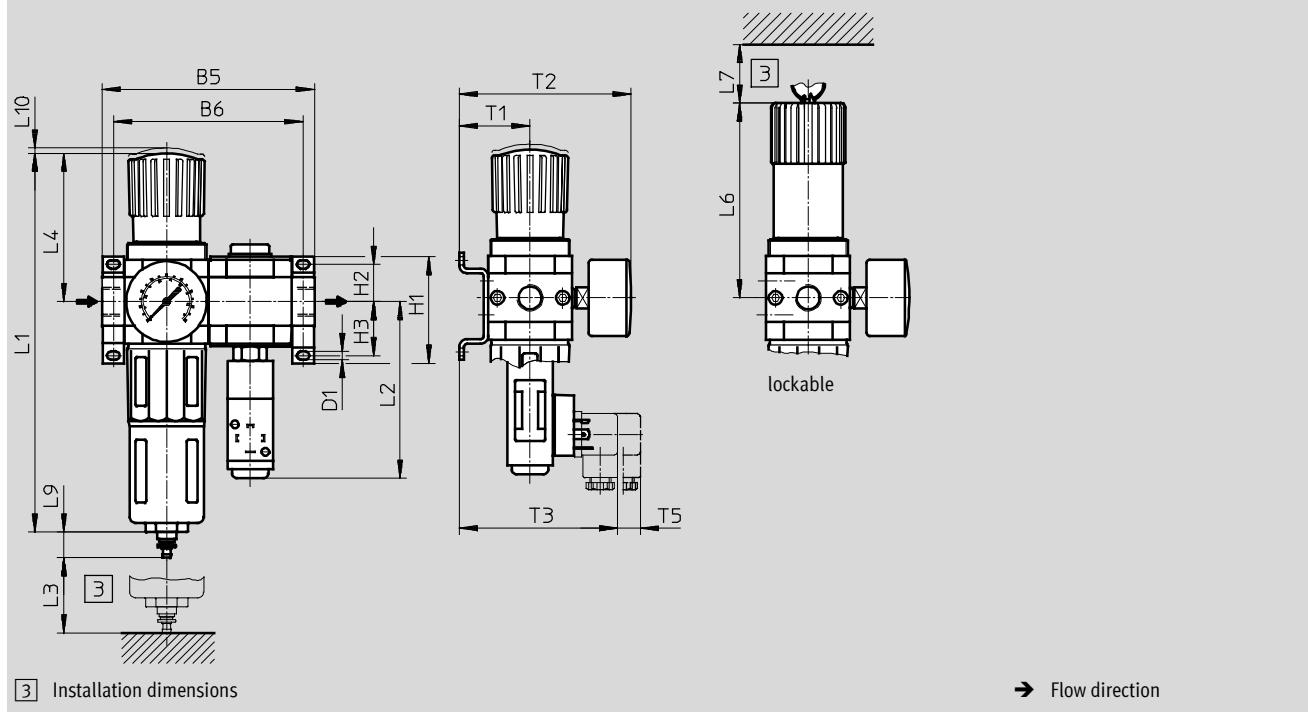

Type	B5	B6	D1	H1	H2	H3	L1	L2	L3	L4	L6	L7	L9	L10	T1	T2	T3	T5
Mini																		
LFR-...-D-MINI-KE (A)	104	92	4.3	43	17.5	17.5	193	108	60	68	98	60	19	3	39	95	97	15
LFRS-...-D-MINI-KE (A)																		
Midi																		
LFR-...-D-MIDI-KE (A)	140	125	5.3	70	24.5	35.5	250	117	80	99	130	60	19	3	47	114	109	15
LFRS-...-D-MIDI-KE (A)																		
Maxi																		
LFR-...-D-MAXI-KE (A)	162	146	5.3	70	24.5	35.5	252	122	90	82	111	60	19	3	53	126	111	15
LFRS-...-D-MAXI-KE (A)							275			105	135							
LFR-...-D-DI-MAXI-KE (A)																		

• † Note: This product conforms to ISO 1179-1 and to ISO 228-1

Service unit combinations LFR-KE/LFRS-KE, D series, metal design

FESTO

Technical data combination LFR-KE/LFRS-KE

Ordering data					
Pressure regulation range 0.5 ... 12 bar, grade of filtration 40 µm, mounting bracket and metal bowl guard					
Size	Connection	Condensate drain turned manually		Condensate drain fully automatic	
		Part No.	Type	Part No.	Type
Filter regulator, branching module with pressure switch					
Mini	G $\frac{1}{8}$	185755	LFR- $\frac{1}{8}$ -D-MINI-KE	185756	LFR- $\frac{1}{8}$ -D-MINI-KE-A
	G $\frac{1}{4}$	185757	LFR- $\frac{1}{4}$ -D-MINI-KE	185758	LFR- $\frac{1}{4}$ -D-MINI-KE-A
Midi	G $\frac{1}{4}$	185759	LFR- $\frac{1}{4}$ -D-MIDI-KE	185760	LFR- $\frac{1}{4}$ -D-MIDI-KE-A
	G $\frac{3}{8}$	185761	LFR- $\frac{3}{8}$ -D-MIDI-KE	185762	LFR- $\frac{3}{8}$ -D-MIDI-KE-A
	G $\frac{1}{2}$	185763	LFR- $\frac{1}{2}$ -D-MIDI-KE	185764	LFR- $\frac{1}{2}$ -D-MIDI-KE-A
Maxi	G $\frac{1}{2}$	186047	LFR- $\frac{1}{2}$ -D-MAXI-KE	186048	LFR- $\frac{1}{2}$ -D-MAXI-KE-A
	G $\frac{3}{4}$	185765	LFR- $\frac{3}{4}$ -D-MAXI-KE	185766	LFR- $\frac{3}{4}$ -D-MAXI-KE-A
Directly actuated pressure regulator with integrated return flow function					
Maxi	G $\frac{1}{2}$	192444	LFR- $\frac{1}{2}$ -D-DI-MAXI-KE	192458	LFR- $\frac{1}{2}$ -D-DI-MAXI-KE-A
	G $\frac{3}{4}$	192451	LFR- $\frac{3}{4}$ -D-DI-MAXI-KE	192465	LFR- $\frac{3}{4}$ -D-DI-MAXI-KE-A

Ordering data					
Pressure regulation range 0.5 ... 12 bar, grade of filtration 40 µm, mounting bracket and metal bowl guard, lockable					
Size	Connection	Condensate drain turned manually		Condensate drain fully automatic	
		Part No.	Type	Part No.	Type
Filter regulator, branching module with pressure switch					
Mini	G $\frac{1}{8}$	195016	LFRS- $\frac{1}{8}$ -D-MINI-KE	195017	LFRS- $\frac{1}{8}$ -D-MINI-KE-A
	G $\frac{1}{4}$	195030	LFRS- $\frac{1}{4}$ -D-MINI-KE	195031	LFRS- $\frac{1}{4}$ -D-MINI-KE-A
Midi	G $\frac{1}{4}$	195044	LFRS- $\frac{1}{4}$ -D-MIDI-KE	195045	LFRS- $\frac{1}{4}$ -D-MIDI-KE-A
	G $\frac{3}{8}$	195058	LFRS- $\frac{3}{8}$ -D-MIDI-KE	195059	LFRS- $\frac{3}{8}$ -D-MIDI-KE-A
	G $\frac{1}{2}$	195072	LFRS- $\frac{1}{2}$ -D-MIDI-KE	195073	LFRS- $\frac{1}{2}$ -D-MIDI-KE-A
Maxi	G $\frac{1}{2}$	195086	LFRS- $\frac{1}{2}$ -D-MAXI-KE	195087	LFRS- $\frac{1}{2}$ -D-MAXI-KE-A
	G $\frac{3}{4}$	195100	LFRS- $\frac{3}{4}$ -D-MAXI-KE	195101	LFRS- $\frac{3}{4}$ -D-MAXI-KE-A

Service unit combinations LFR-KF/LFRS-KF, D series, metal design

Technical data combination LFR-KF/LFRS-KF

LFR/LFRS-...-MINI/MIDI-KF
With condensate drain
manual rotary

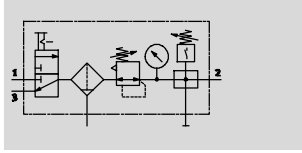

LFR/LFRS-...-MAXI-KF
With condensate drain
manual rotary

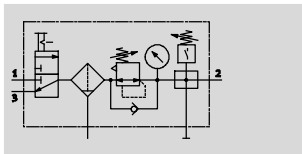

- On-off valve HE manually actuated
- Filter regulator LFR/LFRS
- Branching module FRM with pressure switch
- Mounting accessories

- Flow rate
700 ... 8,400 l/min
- Temperature range
-10 ... +60 °C
- Operating pressure
1 ... 16 bar

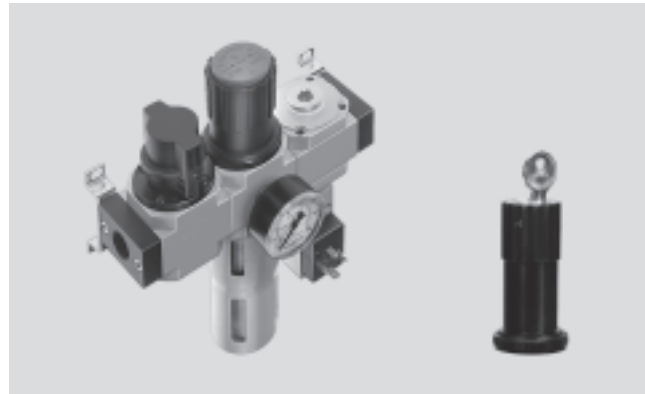

- For unlubricated compressed air
- Operating pressure can be opened and closed
- Two branch connections are available
- Electrical pressure monitoring with adjustable switching pressure
- To ensure safe venting of the system, an additional quick exhaust valve is necessary at the output of the service unit combination

General technical data							
Size	Mini		Midi			Maxi	
Pneumatic connection 1, 2	G $\frac{1}{8}$	G $\frac{1}{4}$	G $\frac{1}{4}$	G $\frac{3}{8}$	G $\frac{1}{2}$	G $\frac{1}{2}$	G $\frac{3}{4}$
Type of mounting	Via accessories						
	In-line installation						
Assembly position	Vertical $\pm 5^\circ$						
Grade of filtration [µm]	40						
Bowl guard	Metal bowl guard						
Condensate drain	Manual rotary						
	Fully automatic						
Actuator lock	Rotary knob with detent						
	Rotary knob with integrated lock						
Pressure regulation range [bar]	0.5 ... 12						
Max. hysteresis [bar]	0.2	0.2	0.25	0.3	0.25	0.2	0.2
Pressure indication	Via pressure gauge						
Max. condensate volume [cm ³]	22		43			80 (43) ¹⁾	

1) For the LFR-...-D-DI.

- Note: This product conforms to ISO 1179-1 and to ISO 228-1

Standard nominal flow rate $q_{nN}^{1)}$ [l/min]							
Connection	Mini		Midi			Maxi	
	G $\frac{1}{8}$	G $\frac{1}{4}$	G $\frac{1}{4}$	G $\frac{3}{8}$	G $\frac{1}{2}$	G $\frac{1}{2}$	G $\frac{3}{4}$
In main flow direction 1 \rightarrow 2	700	1,050	1,720	2,420	2,920	8,000 (5,000) ²⁾	8,400 (6,000) ²⁾

1) Measured at $p_1 = 10$ bar, $p_2 = 6$ bar and $\Delta p = 1$ bar.

2) For the LFR-...-D-DI.

Service unit combinations LFR-KF/LFRS-KF, D series, metal design

Technical data combination LFR-KF/LFRS-KF

Operating and environmental conditions		
Condensate drain	Manual rotary	Fully automatic
Operating pressure [bar]	1 ... 16	2 ... 12
Operating medium	Compressed air in accordance with ISO 8573-1:2010 [-:-:-]	
Ambient temperature [°C]	-10 ... +60	
Temperature of medium [°C]	-10 ... +60	
Corrosion resistance class CRC ¹⁾	2	
Certification	Germanischer Lloyd	

1) Corrosion resistance class 2 according to Festo standard 940 070
 Components subject to moderate corrosion stress. Externally visible parts with primarily decorative surface requirements which are in direct contact with a normal industrial environment or media such as coolants or lubricating agents.

Weight [g]			
Size	Mini	Midi	Maxi
LFR	1,200	2,400	3,300 (3,500) ¹⁾
LFRS	1,300	2,640	3,400

1) For the LFR-...-D-DI.

 - Note
 Materials → Technical data of the individual devices

Standard flow rate qn as a function of the output pressure p2

LFR-1/2-D-DI-MAXI-KF(-A)

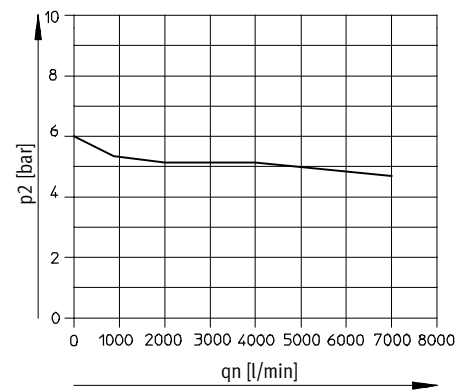

Primary pressure p1 = 10 bar

Service unit combinations LFR-KF/LFRS-KF, D series, metal design

Technical data combination LFR-KF/LFRS-KF

Dimensions Download CAD data → www.festo.com

LFR/LFRS-...-KF

3 Installation dimensions → Flow direction

Type	B7	B8	D1	H1	H2	H3	L1	L2	L3	L4	L6	L7	L9	L10	T1	T2	T3	T5
Mini																		
LFR-...-D-MINI-KF (A)	144	132	4.3	43	17.5	17.5	193	108	60	68	98	60	19	3	39	95	97	15
LFRS-...-D-MINI-KF (A)																		
Midi																		
LFR-...-D-MIDI-KF (A)	195	180	5.3	70	24.5	35.5	250	117	80	99	130	60	19	3	47	114	105	15
LFRS-...-D-MIDI-KF (A)																		
Maxi																		
LFR-...-D-MAXI-KF (A)	228	212	5.3	70	24.5	35.5	252	122	90	82	111	60	19	3	53	126	111	15
LFRS-...-D-MAXI-KF (A)							275			105	135							
LFR-...-D-DI-MAXI-KF (A)																		

⚡ Note: This product conforms to ISO 1179-1 and to ISO 228-1

Service unit combinations LFR-KF/LFRS-KF, D series, metal design

FESTO

Technical data combination LFR-KF/LFRS-KF

Ordering data					
Pressure regulation range 0.5 ... 12 bar, grade of filtration 40 µm, mounting bracket and metal bowl guard					
Size	Connection	Condensate drain turned manually		Condensate drain fully automatic	
		Part No.	Type	Part No.	Type
On-off valve, filter regulator, branching module with pressure switch					
Mini	G $\frac{1}{8}$	185767	LFR- $\frac{1}{8}$ -D-MINI-KF	185768	LFR- $\frac{1}{8}$ -D-MINI-KF-A
	G $\frac{1}{4}$	185769	LFR- $\frac{1}{4}$ -D-MINI-KF	185770	LFR- $\frac{1}{4}$ -D-MINI-KF-A
Midi	G $\frac{1}{4}$	185771	LFR- $\frac{1}{4}$ -D-MIDI-KF	185772	LFR- $\frac{1}{4}$ -D-MIDI-KF-A
	G $\frac{3}{8}$	185773	LFR- $\frac{3}{8}$ -D-MIDI-KF	185774	LFR- $\frac{3}{8}$ -D-MIDI-KF-A
	G $\frac{1}{2}$	185775	LFR- $\frac{1}{2}$ -D-MIDI-KF	185776	LFR- $\frac{1}{2}$ -D-MIDI-KF-A
Maxi	G $\frac{1}{2}$	186049	LFR- $\frac{1}{2}$ -D-MAXI-KF	186050	LFR- $\frac{1}{2}$ -D-MAXI-KF-A
	G $\frac{3}{4}$	185777	LFR- $\frac{3}{4}$ -D-MAXI-KF	185778	LFR- $\frac{3}{4}$ -D-MAXI-KF-A
Directly actuated pressure regulator with integrated return flow function					
Maxi	G $\frac{1}{2}$	192445	LFR- $\frac{1}{2}$ -D-DI-MAXI-KF	192459	LFR- $\frac{1}{2}$ -D-DI-MAXI-KF-A
	G $\frac{3}{4}$	192452	LFR- $\frac{3}{4}$ -D-DI-MAXI-KF	192466	LFR- $\frac{3}{4}$ -D-DI-MAXI-KF-A

Ordering data					
Pressure regulation range 0.5 ... 12 bar, grade of filtration 40 µm, mounting bracket and metal bowl guard, lockable					
Size	Connection	Condensate drain turned manually		Condensate drain fully automatic	
		Part No.	Type	Part No.	Type
On-off valve, filter regulator, branching module with pressure switch					
Mini	G $\frac{1}{8}$	195018	LFRS- $\frac{1}{8}$ -D-MINI-KF	195019	LFRS- $\frac{1}{8}$ -D-MINI-KF-A
	G $\frac{1}{4}$	195032	LFRS- $\frac{1}{4}$ -D-MINI-KF	195033	LFRS- $\frac{1}{4}$ -D-MINI-KF-A
Midi	G $\frac{1}{4}$	195046	LFRS- $\frac{1}{4}$ -D-MIDI-KF	195047	LFRS- $\frac{1}{4}$ -D-MIDI-KF-A
	G $\frac{3}{8}$	195060	LFRS- $\frac{3}{8}$ -D-MIDI-KF	195061	LFRS- $\frac{3}{8}$ -D-MIDI-KF-A
	G $\frac{1}{2}$	195074	LFRS- $\frac{1}{2}$ -D-MIDI-KF	195075	LFRS- $\frac{1}{2}$ -D-MIDI-KF-A
Maxi	G $\frac{1}{2}$	195088	LFRS- $\frac{1}{2}$ -D-MAXI-KF	195089	LFRS- $\frac{1}{2}$ -D-MAXI-KF-A
	G $\frac{3}{4}$	195102	LFRS- $\frac{3}{4}$ -D-MAXI-KF	195103	LFRS- $\frac{3}{4}$ -D-MAXI-KF-A

Service unit combinations LFR-KG/LFRS-KG, D series, metal design

Technical data combination LFR-KG/LFRS-KG

LFR/LFRS-...-MINI/MIDI-KG
With condensate drain
manual rotary

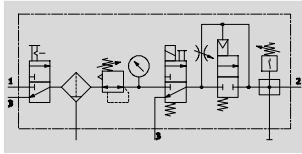

LFR/LFRS-...-MAXI-KG
With condensate drain
manual rotary

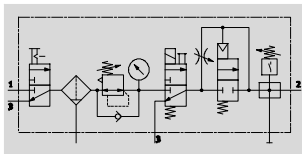

- On-off valve HE manually actuated
- Filter regulator LFR/LFRS
- On-off valve HEE solenoid actuated, 24 V DC
- Soft-start valve HEL pneumatically actuated
- Branching module FRM with pressure switch
- Mounting accessories

- Flow rate
575 ... 4,900 l/min
- Temperature range
-10 ... +60 °C
- Operating pressure
3 ... 16 bar

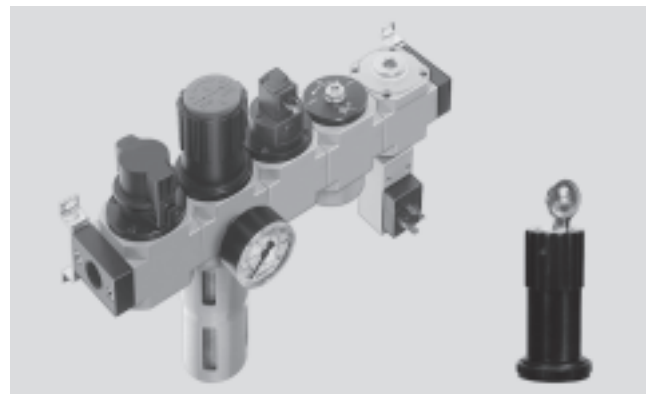

- For unlubricated compressed air
- To ensure safe venting of the system, an additional quick exhaust valve is necessary at the output of the service unit combination
- Two branch connections are available
- Gradual pressure build-up prevents sudden, unpredictable movements
- Electrical pressure monitoring with adjustable switching pressure

General technical data							
Size	Mini		Midi			Maxi	
Pneumatic connection 1, 2	G1/8	G1/4	G1/4	G3/8	G1/2	G1/2	G3/4
Type of mounting	Via accessories						
	In-line installation						
Assembly position	Vertical ±5°						
Grade of filtration [µm]	40						
Bowl guard	Metal bowl guard						
Condensate drain	Manual rotary						
	Fully automatic						
Actuator lock	Rotary knob with detent						
	Rotary knob with integrated lock						
Pressure regulation range [bar]	2.5 ... 12						
Max. hysteresis [bar]	0.15	0.15	0.25	0.2	0.2	0.25	0.25
Pressure indication	Via pressure gauge						
Max. condensate volume [cm ³]	22		43			80 (43) ¹⁾	

1) For the LFR-...-D-DI.

- - Note: This product conforms to ISO 1179-1 and to ISO 228-1

Standard nominal flow rate $q_{mN}^{1)}$ [l/min]							
Connection	Mini		Midi			Maxi	
	G1/8	G1/4	G1/4	G3/8	G1/2	G1/2	G3/4
In main flow direction 1 → 2	575	715	1,370	1,680	1,740	4,200 (2,500) ²⁾	4,900 (3,000) ²⁾

1) Measured at p₁ = 10 bar, p₂ = 6 bar and Δp = 1 bar.

2) For the LFR-...-D-DI.

Service unit combinations LFR-KG/LFRS-KG, D series, metal design

Technical data LFR-KG/LFRS-KG

Operating and environmental conditions		
Condensate drain	Manual rotary	Fully automatic
Operating pressure [bar]	3 ... 16	3 ... 12
Operating medium	Compressed air in accordance with ISO 8573-1:2010 [-:-:-]	
Ambient temperature [°C]	-10 ... +60	
Temperature of medium [°C]	-10 ... +60	
Corrosion resistance class CRC ¹⁾	2	

1) Corrosion resistance class 2 according to Festo standard 940 070
 Components subject to moderate corrosion stress. Externally visible parts with primarily decorative surface requirements which are in direct contact with a normal industrial environment or media such as coolants or lubricating agents.

Weight [g]			
Size	Mini	Midi	Maxi
LFR	1,500	3,400	5,200 (5,400) ¹⁾
LFRS	1,600	3,640	5,300

1) For the LFR-...-D-DI.

 - Note
 Materials → Technical data of the individual devices

Standard flow rate qn as a function of the output pressure p2

LFR-1/2-D-DI-MAXI-KG(-A)

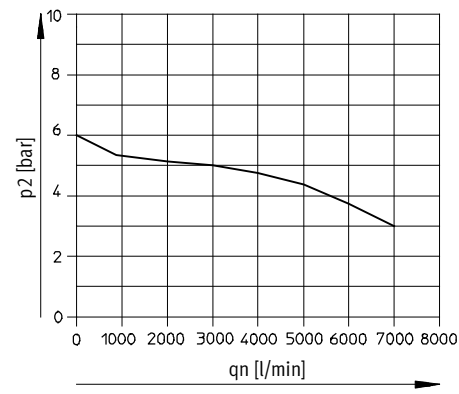

Primary pressure p1 = 10 bar

Service unit combinations LFR-KG/LFRS-KG, D series, metal design

Technical data LFR-KG/LFRS-KG

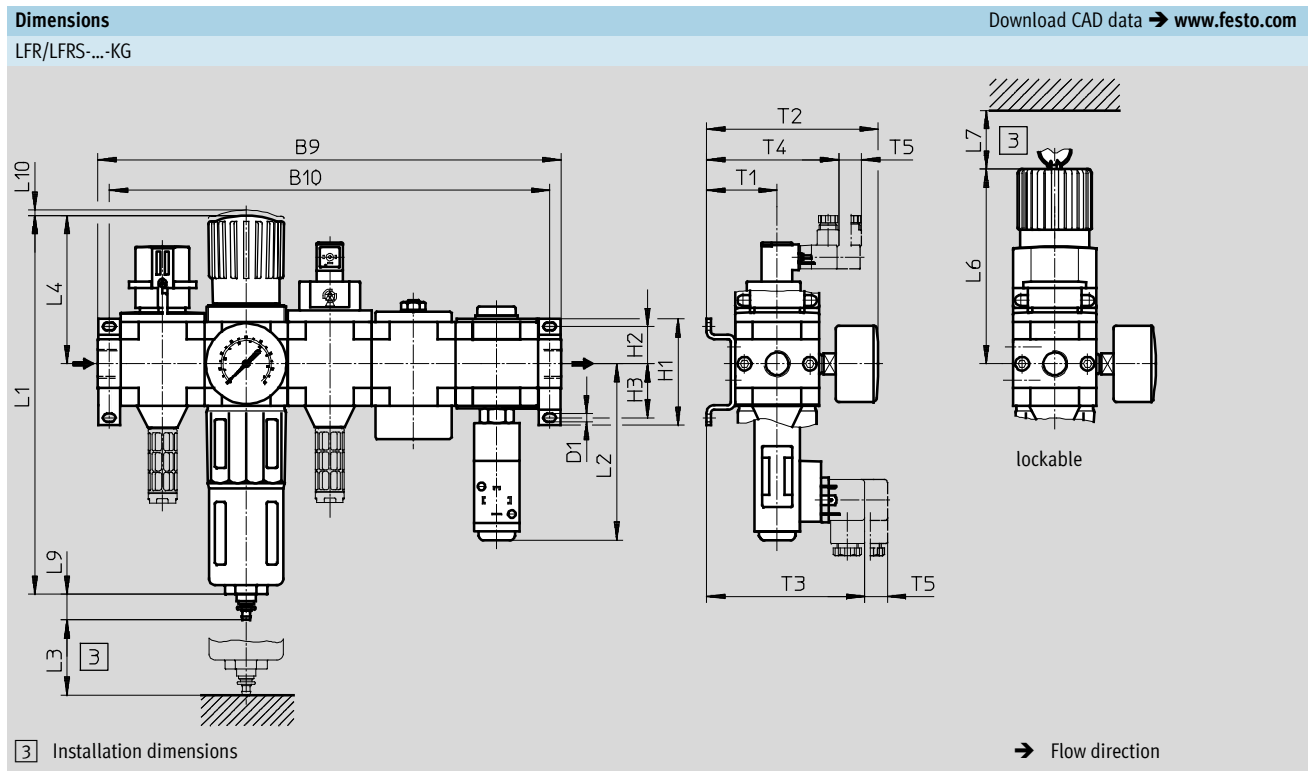

Type	B9	B10	D1	H1	H2	H3	L1	L2	L3	L4	L6	L7	L9	L10	T1	T2	T3	T4	T5
Mini																			
LFR-...-D-MINI-KG (A)	244	212	4.3	43	17.5	17.5	193	108	60	68	98	60	19	3	39	95	97	78	15
LFRS-...-D-MINI-KG (A)																			
Midi																			
LFR-...-D-MIDI-KG (A)	305	290	5.3	70	24.5	35.5	250	117	80	99	130	60	19	3	47	114	105	86	15
LFRS-...-D-MIDI-KG (A)																			
Maxi																			
LFR-...-D-MAXI-KG (A)	360	344	5.3	70	24.5	35.5	252	122	90	82	111	60	19	3	53	126	111	92	15
LFRS-...-D-MAXI-KG (A)							275			105	135								
LFR-...-D-DI-MAXI-KG (A)																			

Note: This product conforms to ISO 1179-1 and to ISO 228-1

Service unit combinations LFR-KG/LFRS-KG, D series, metal design

FESTO

Technical data LFR-KG/LFRS-KG

Ordering data					
Pressure regulation range 2.5 ... 12 bar, grade of filtration 40 µm, mounting bracket and metal bowl guard					
Size	Connection	Condensate drain turned manually		Condensate drain fully automatic	
		Part No.	Type	Part No.	Type
On-off valve, filter regulator, on-off valve with solenoid coil 24 V DC, soft-start valve, branching module with pressure switch					
Mini	G $\frac{1}{8}$	185779	LFR- $\frac{1}{8}$ -D-MINI-KG	185780	LFR- $\frac{1}{8}$ -D-MINI-KG-A
	G $\frac{1}{4}$	185781	LFR- $\frac{1}{4}$ -D-MINI-KG	185782	LFR- $\frac{1}{4}$ -D-MINI-KG-A
Midi	G $\frac{1}{4}$	185783	LFR- $\frac{1}{4}$ -D-MIDI-KG	185784	LFR- $\frac{1}{4}$ -D-MIDI-KG-A
	G $\frac{3}{8}$	185785	LFR- $\frac{3}{8}$ -D-MIDI-KG	185786	LFR- $\frac{3}{8}$ -D-MIDI-KG-A
	G $\frac{1}{2}$	185787	LFR- $\frac{1}{2}$ -D-MIDI-KG	185788	LFR- $\frac{1}{2}$ -D-MIDI-KG-A
Maxi	G $\frac{1}{2}$	186051	LFR- $\frac{1}{2}$ -D-MAXI-KG	186052	LFR- $\frac{1}{2}$ -D-MAXI-KG-A
	G $\frac{3}{4}$	185789	LFR- $\frac{3}{4}$ -D-MAXI-KG	185790	LFR- $\frac{3}{4}$ -D-MAXI-KG-A
Directly actuated pressure regulator with integrated return flow function					
Maxi	G $\frac{1}{2}$	192446	LFR- $\frac{1}{2}$ -D-DI-MAXI-KG	192460	LFR- $\frac{1}{2}$ -D-DI-MAXI-KG-A
	G $\frac{3}{4}$	192453	LFR- $\frac{3}{4}$ -D-DI-MAXI-KG	192467	LFR- $\frac{3}{4}$ -D-DI-MAXI-KG-A

Ordering data					
Pressure regulation range 2.5 ... 12 bar, grade of filtration 40 µm, mounting bracket and metal bowl guard, lockable					
Size	Connection	Condensate drain turned manually		Condensate drain fully automatic	
		Part No.	Type	Part No.	Type
On-off valve, filter regulator, on-off valve with solenoid coil 24 V DC, soft-start valve, branching module with pressure switch					
Mini	G $\frac{1}{8}$	195020	LFRS- $\frac{1}{8}$ -D-MINI-KG	195021	LFRS- $\frac{1}{8}$ -D-MINI-KG-A
	G $\frac{1}{4}$	195034	LFRS- $\frac{1}{4}$ -D-MINI-KG	195035	LFRS- $\frac{1}{4}$ -D-MINI-KG-A
Midi	G $\frac{1}{4}$	195048	LFRS- $\frac{1}{4}$ -D-MIDI-KG	195049	LFRS- $\frac{1}{4}$ -D-MIDI-KG-A
	G $\frac{3}{8}$	195062	LFRS- $\frac{3}{8}$ -D-MIDI-KG	195063	LFRS- $\frac{3}{8}$ -D-MIDI-KG-A
	G $\frac{1}{2}$	195076	LFRS- $\frac{1}{2}$ -D-MIDI-KG	195077	LFRS- $\frac{1}{2}$ -D-MIDI-KG-A
Maxi	G $\frac{1}{2}$	195090	LFRS- $\frac{1}{2}$ -D-MAXI-KG	195091	LFRS- $\frac{1}{2}$ -D-MAXI-KG-A
	G $\frac{3}{4}$	195104	LFRS- $\frac{3}{4}$ -D-MAXI-KG	195105	LFRS- $\frac{3}{4}$ -D-MAXI-KG-A

Service unit combinations LFR-K/LFRS-K, D series

FESTO

Accessories

Ordering data – Angled socket PEV					Technical data → Internet: pev-1/4	
	Description	Operating voltage range	Electrical connection	Switching status display	Part No.	Type
	for PEV-1/4-...-OD	15 ... 30 V DC	4-pin	Yellow LED	164274	PEV-1/4-WD-LED-24
		≤ 230 V AC ≤ 180 V DC	4-pin	Yellow LED	164275	PEV-1/4-WD-LED-230

Ordering data – Plug socket MSSD					Technical data → Internet: mssd	
	Description	Operating voltage range	Electrical connection	Type of mounting cable connection	Part No.	Type
	for PEV-1/4-...-OD	≤ 250 V AC/DC	3-pin	Clamping screws	171157	MSSD-C-4P
	for on-off valve HEE	≤ 250 V AC/DC	3-pin	Clamping screws	151687	MSSD-EB
			4-pin	Insulation displacement technology	192745	MSSD-EB-S-M14

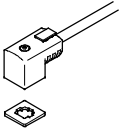
Ordering data – Plug socket with cable KMEB						Technical data → Internet: kmeb	
	Description	Operating voltage range	Electrical connection	Switching status display	Cable length [m]	Part No.	Type
	for on-off valve HEE	24 V DC	3-pin	LED	2.5	151688	KMEB-1-24-2,5-LED
					5	151689	KMEB-1-24-5-LED
					10	193457	KMEB-1-24-10-LED
		230 V AC	3-pin	–	2.5	151690	KMEB-1-230AC-2,5
					5	151691	KMEB-1-230AC-5

Ordering data – Illuminating seal MEB-LD				Technical data → Internet: meb	
	Description	Operating voltage range		Part No.	Type
	for plug socket with cable KMEB and plug socket MSSD-EB	12 ... 24 V DC		151717	MEB-LD-12-24DC
		230 V DC/AC ±10%		151718	MEB-LD-230AC